

Sähköasennus!

**KAIKKI SÄHKÖTYÖT VOI
SUORITTA A VAIN PÄTEVÄ
SÄHKÖASENTAJA!**

Irrota 6 ruuvia ja
laudat

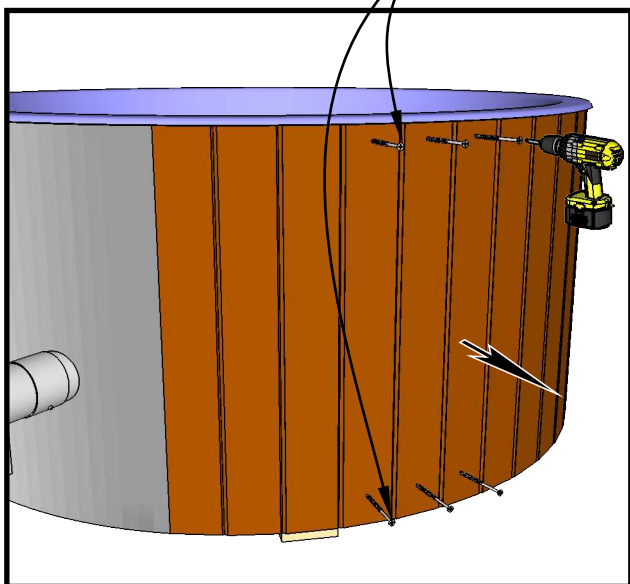

I

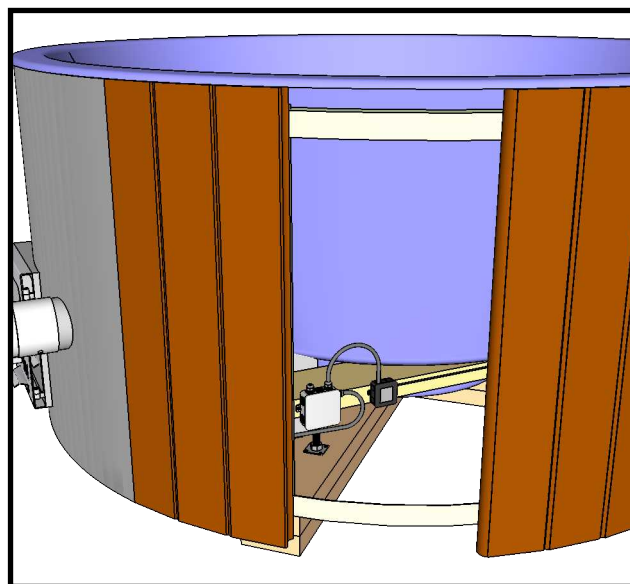

II

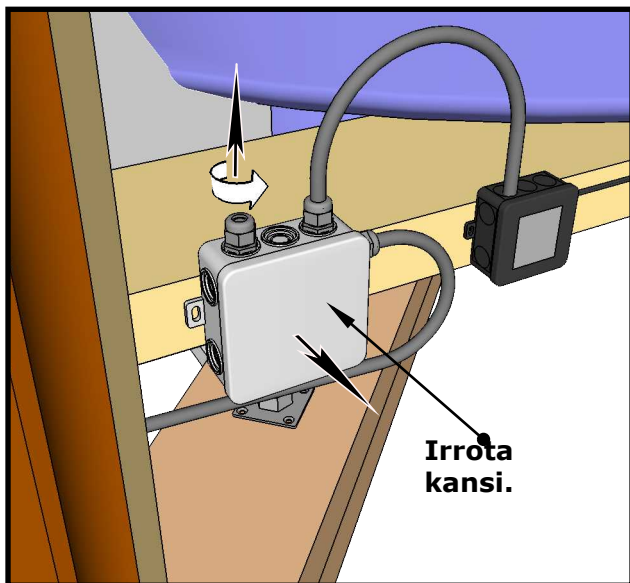

Irrota
kansi.

III

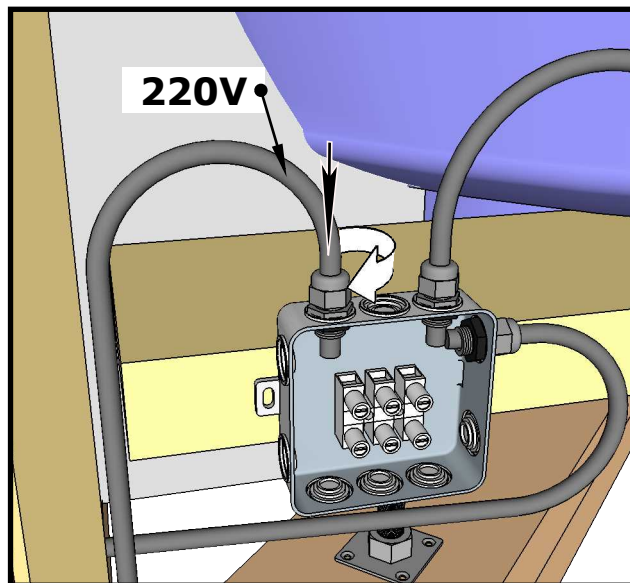

220V

VI

Sähköasennus!

**KAIKKI SÄHKÖTYÖT VOI
SUORITTA A VAIN PÄTEVÄ
SÄHKÖASENTAJA!**

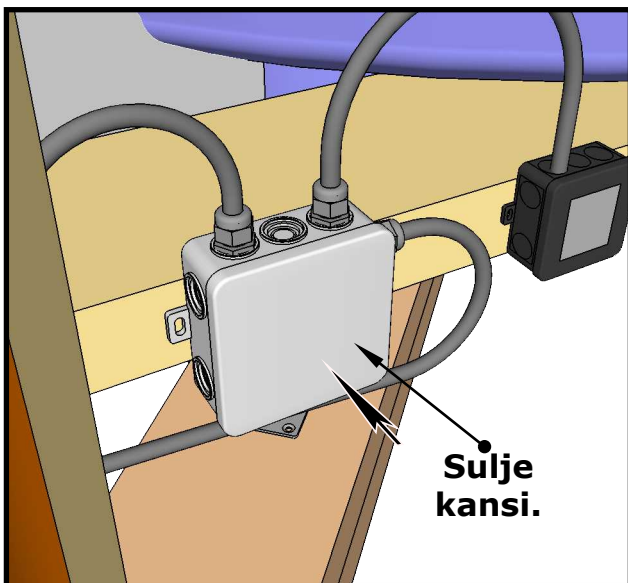
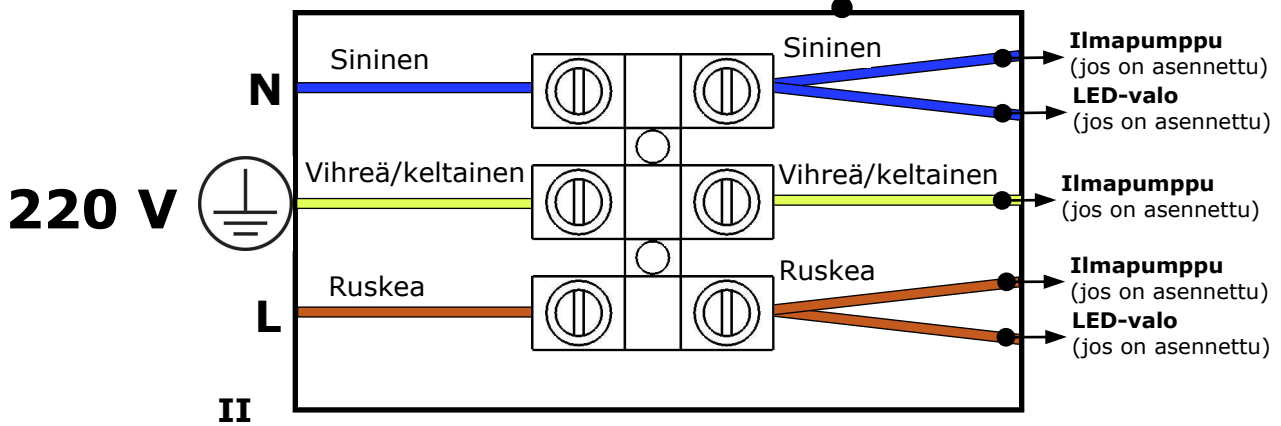
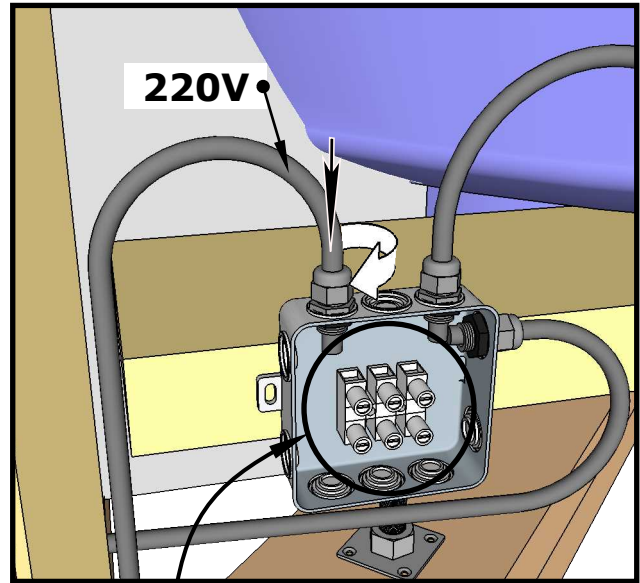

**Ruuvaa laudat
takaisin.**

