

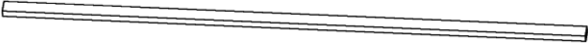







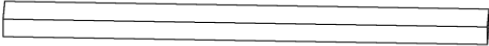
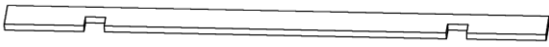

T74 ESPOO PUUCEE

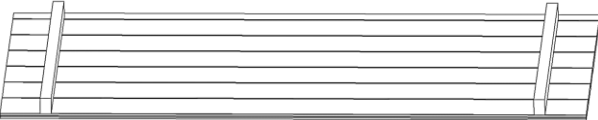
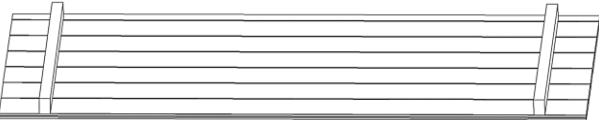
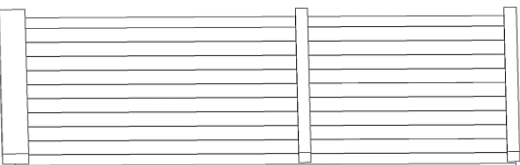
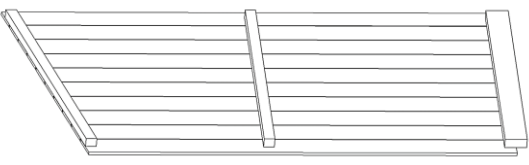
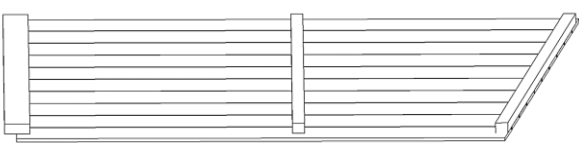

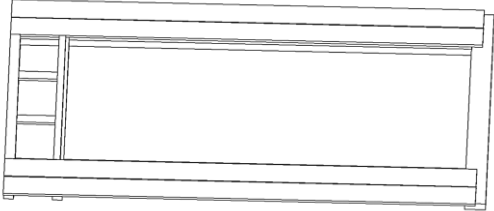
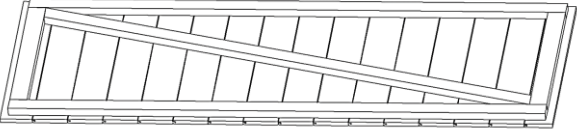
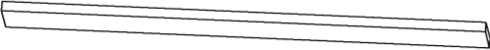
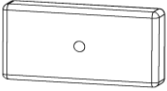
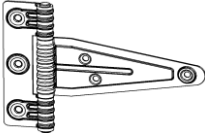
Osaluettelo

1.		OTSALAUTA 28x70x1485mm	2kpl
2.		OTSALAUTA 28x70x1429mm	2kpl
3.		VINOTUKI 28x45x1400mm	3kpl
4.		RUNKOPUU POHJAAN 48x98x1050mm	2kpl
5.		LATTIALAUTA 20x85x1195mm	1kpl
6.		LATTIALAUTA 20x145x1195mm	7kpl
7.		LATTIALAUTA 20x85x1195mm	1kpl
8.		KATTOELEMENTTI 15x745x1485mm	1kpl
9.		KATTOELEMENTTI 15x745x1485mm	1kpl
10.		TAKASEINÄ	1kpl
11.		SIVUSEINÄ VASEN	1kpl
12.		SIVUSEINÄ OIKEA	1kpl

Osaluettelo

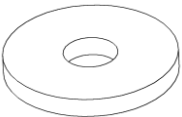
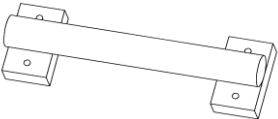
<p>13.</p> 	<p>ETUSEINÄ</p>	<p>1kpl</p>
<p>14.</p> 	<p>OVI</p>	<p>1kpl</p>
<p>15.</p> 	<p>KATTOTUKI 48x48x1090mm</p>	<p>1kpl</p>
<p>16.</p> 	<p>SALPA</p>	<p>1kpl</p>
<p>16.</p> 	<p>SARANA</p>	<p>2kpl</p>
<p>17.</p> 	<p>HAKA</p>	<p>1kpl</p>
<p>18.</p> 	<p>RUUVI 5X90mm</p>	<p>14kpl</p>
<p>19.</p> 	<p>RUUVI 4x55mm</p>	<p>132kpl</p>
<p>20.</p> 	<p>RUUVI 5x40mm</p>	<p>1kpl</p>
<p>21.</p> 	<p>RUUVI 4x40mm</p>	<p>31kpl</p>
<p>22.</p> 	<p>ALUSLEVY 5mm</p>	<p>2kpl</p>
<p>23.</p> 	<p>OVENKAHVA</p>	<p>1kpl</p>

1. Asenna elementit toisiinsa 4x55mm ruuveilla (kuva 1.)
2. Asenna pohjan keskelle 48x98x1150mm runkopuu 5x90mm ruuveilla (kuva 2.)
HUOM! Käyttäessäsi kompostikäymälää asenna pohjaan kaksi runkopuuta niin että keskelle jää riittävästi tilaa:
3. Asenna lattialaudat jakamalla ne ensin paikalleen aloittamalla takaseinästä n.85mm leveällä laudalla jättäen pienet välit toisiinsa nähden,tämän jälkeen kiinnitä jokaiseen runkopuuhun 2kpl 4x55mm ruuvilla. Tarkista ristimitta ennen asennusta. (kuva 2.-3.)
4. Asenna katon keskelle runkopuu 5x90mm ruuveilla. (kuva 4.)
5. Asenna elementit paikalleen 4x55mm ruuveilla. (kuva 5.)
6. Asenna otsalaudat paikalleen 4x55mm ruuveilla. (kuva 6.)
7. Asenna vinotuet 4x40mm ruuveilla. (kuva 7.)
8. Asenna saranat oveen ja sen jälkeen ovi paikalleen. (kuva 8-9.)
9. Asenna haka,salpa ja kahva oveen. (kuva 8-11.)
10. Varmista sisätilan riittävä ilmanvaihto,ettei kosteustaso nouse korkeaksi ja luo kasvupohjaa homeelle.Koska sääolot vaihtelevat ja kosteus nousee myös sisällä korkeaksi,kannattaa myös sisätilat pintakäsitellä homehtumisen estämiseksi.

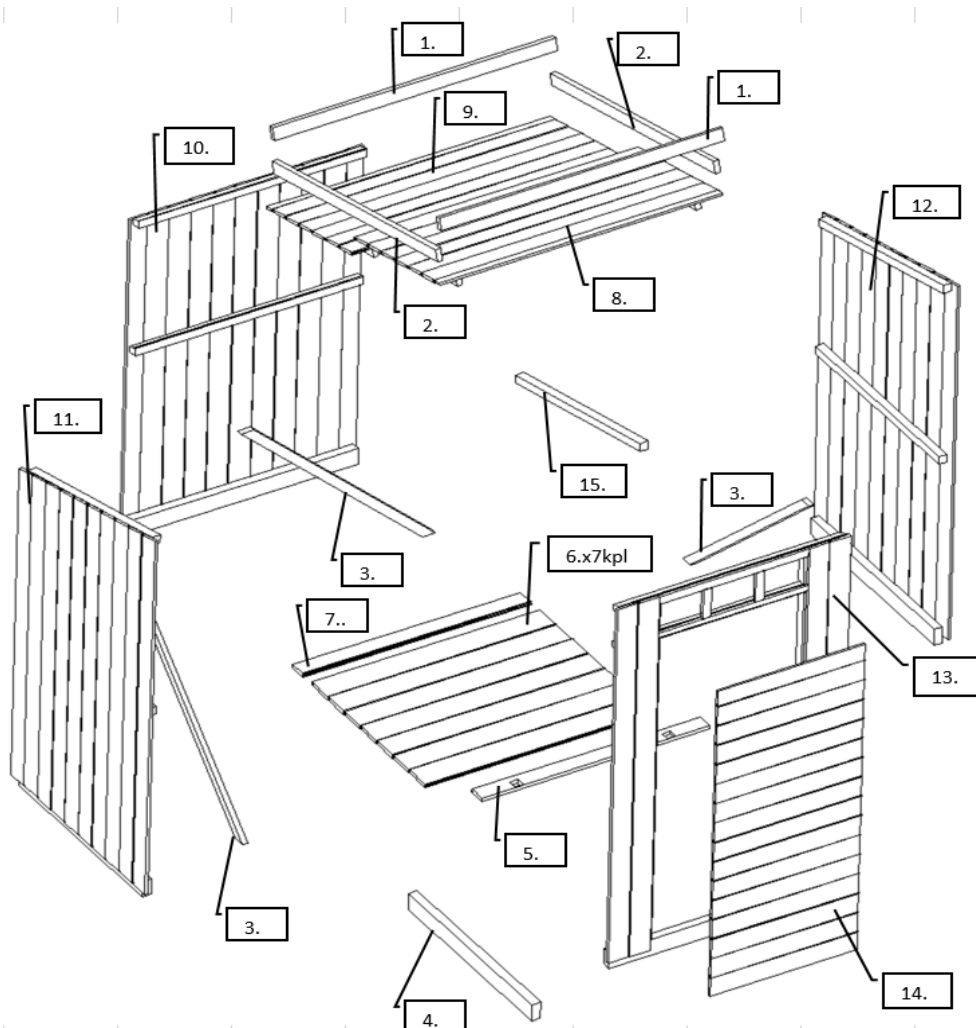

Kuva 1

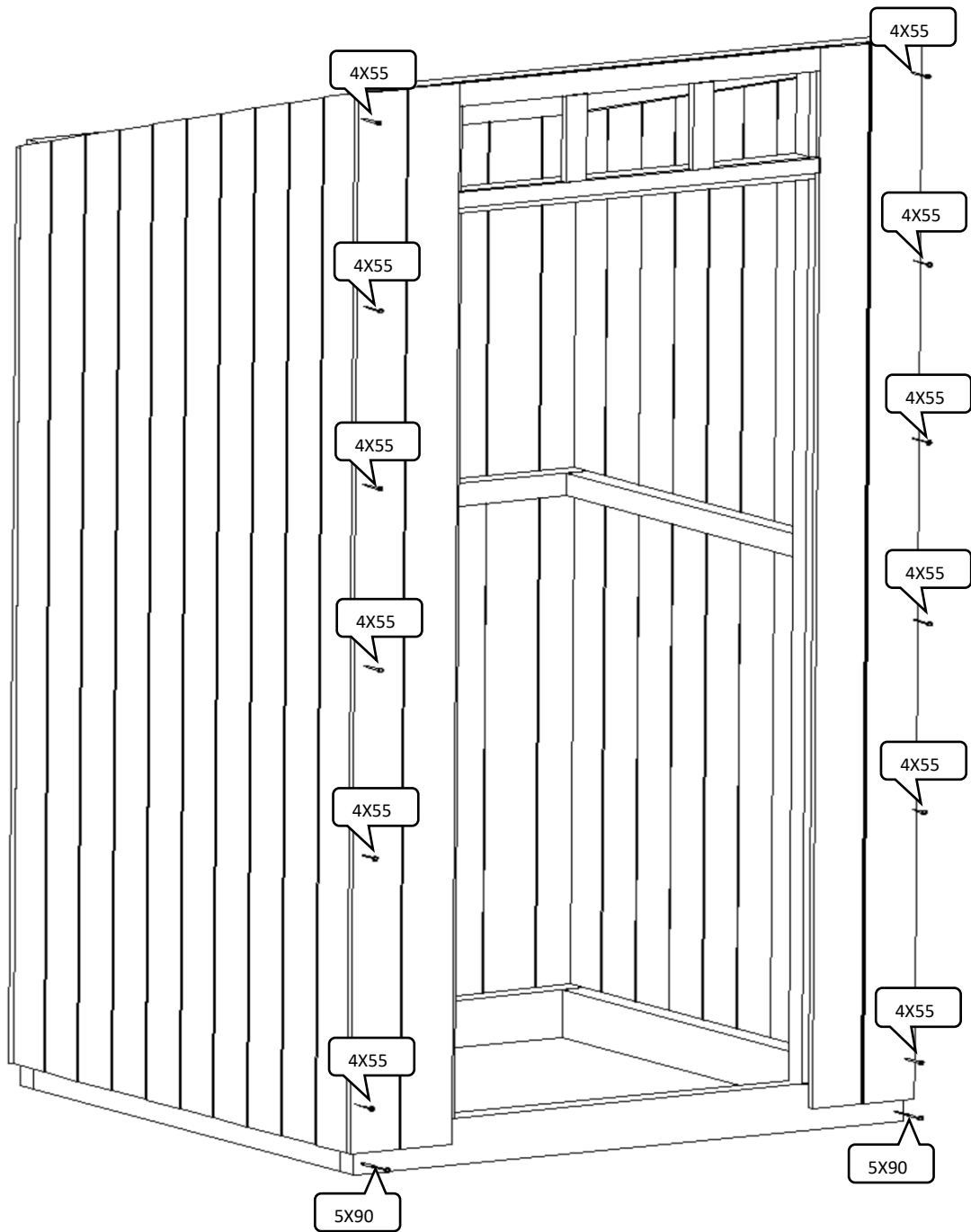

Kuva 2

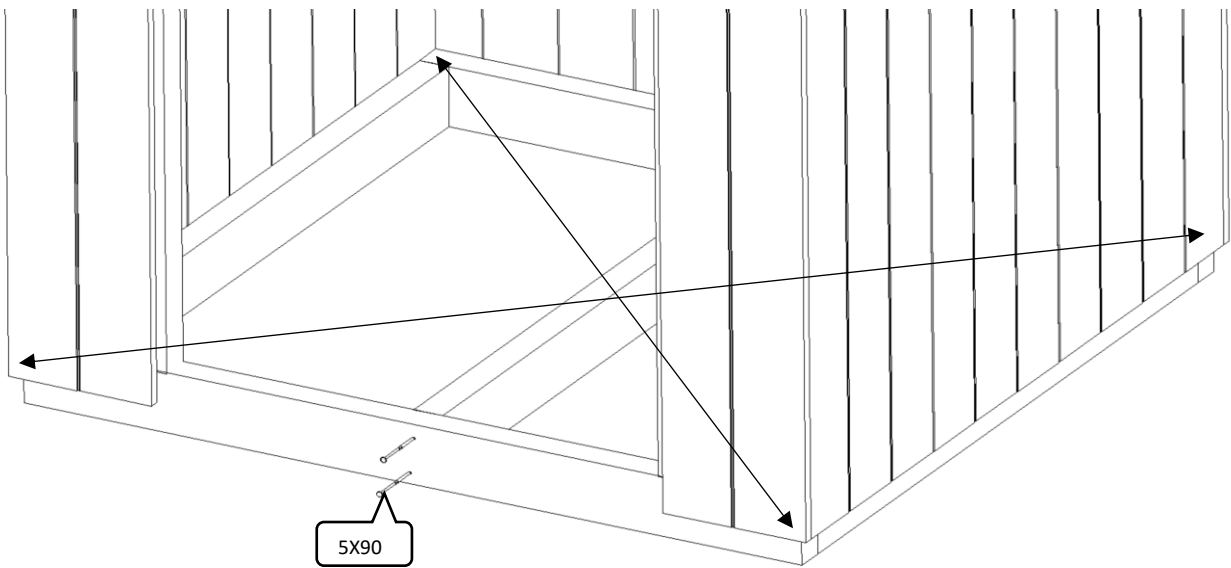

Mittaa ristimita

Kuva 3

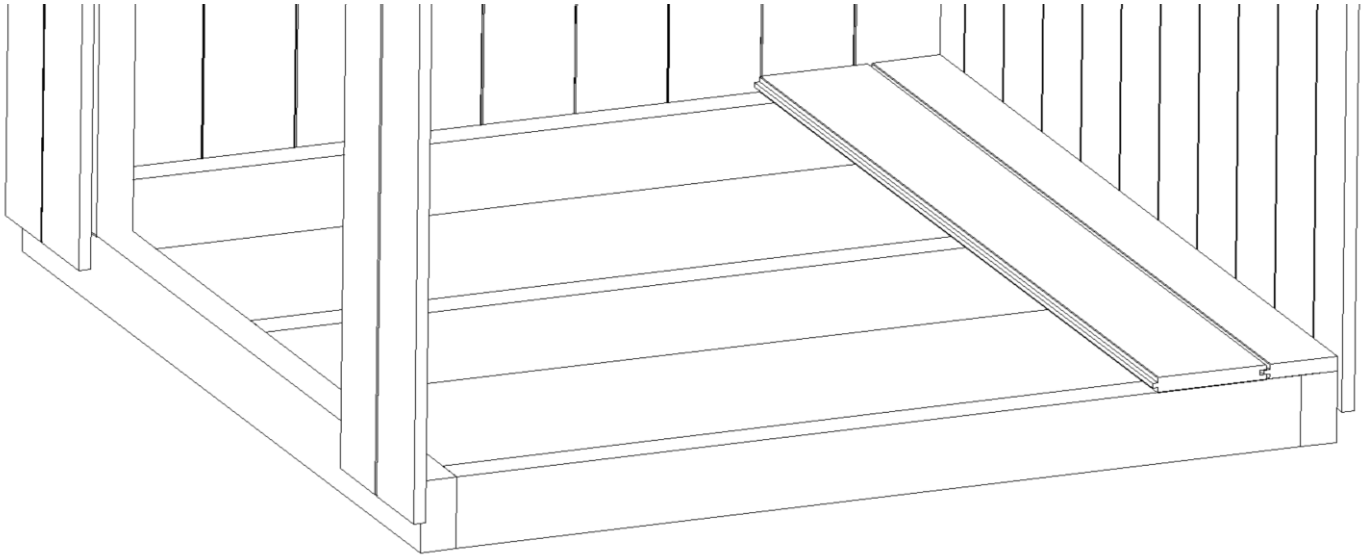

Kuva 4

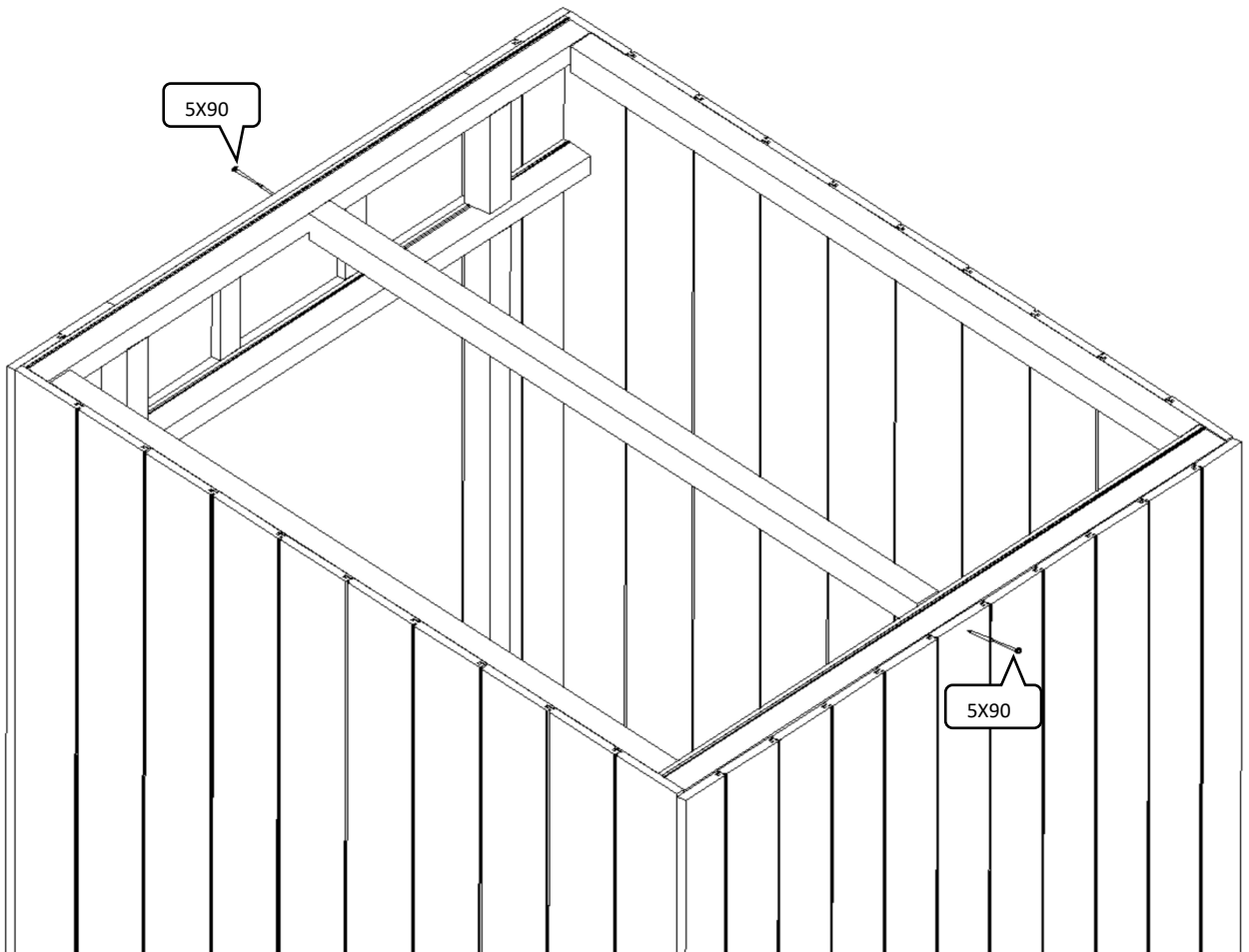

Kuva 5

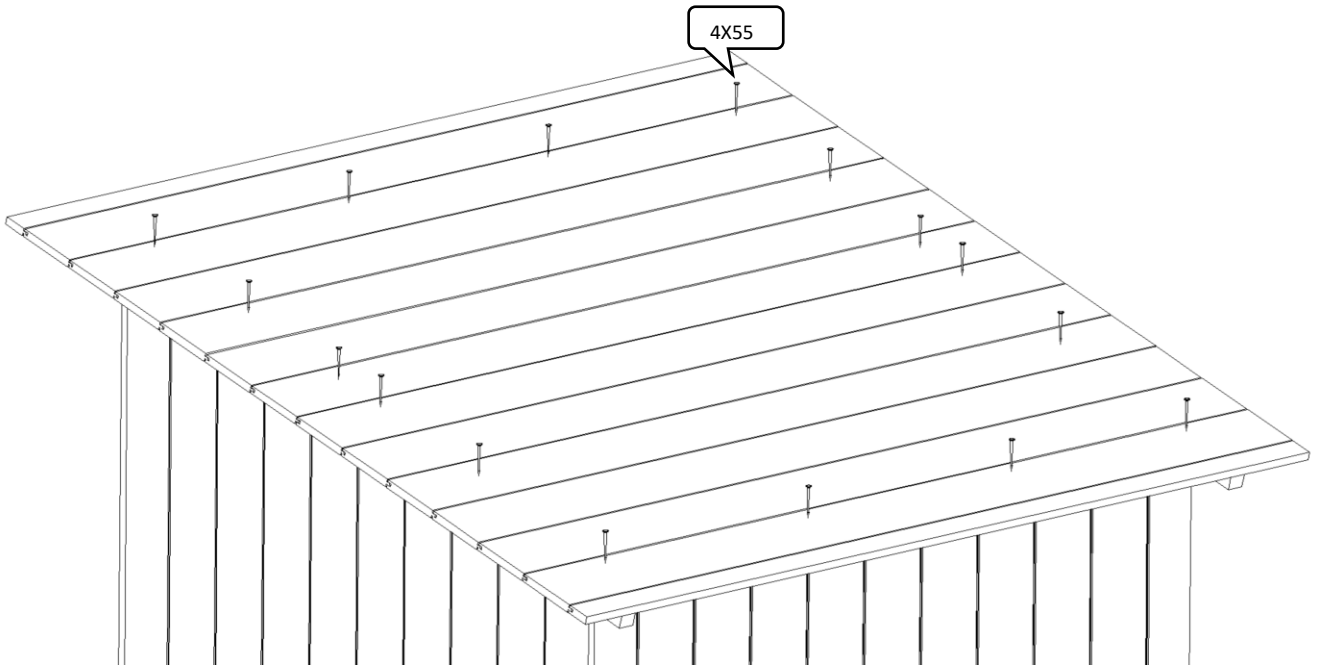

Kuva 6

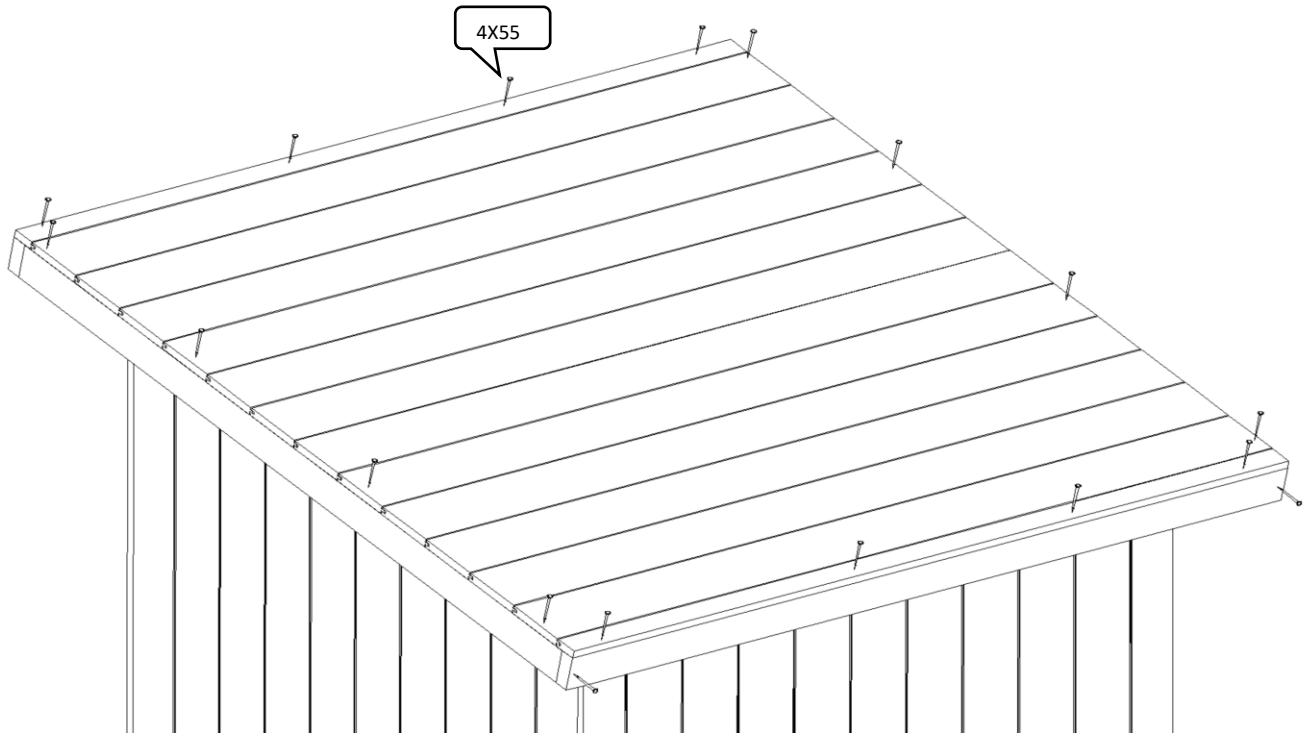

Kuva 7

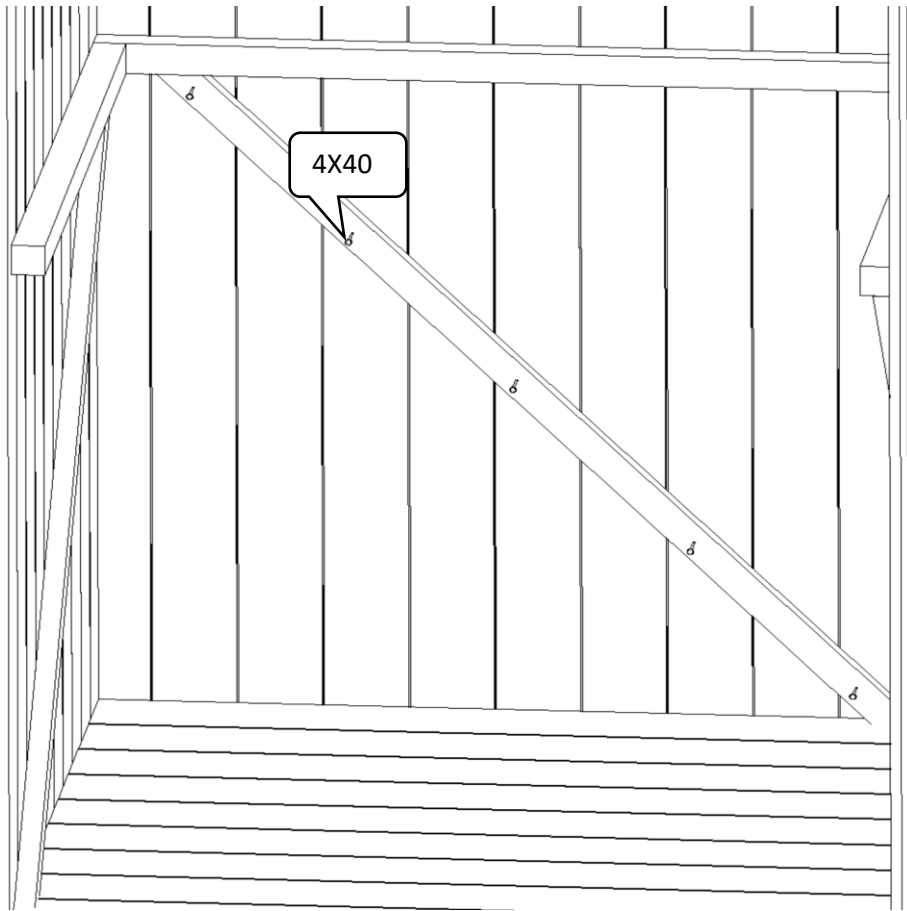

Kuva 8

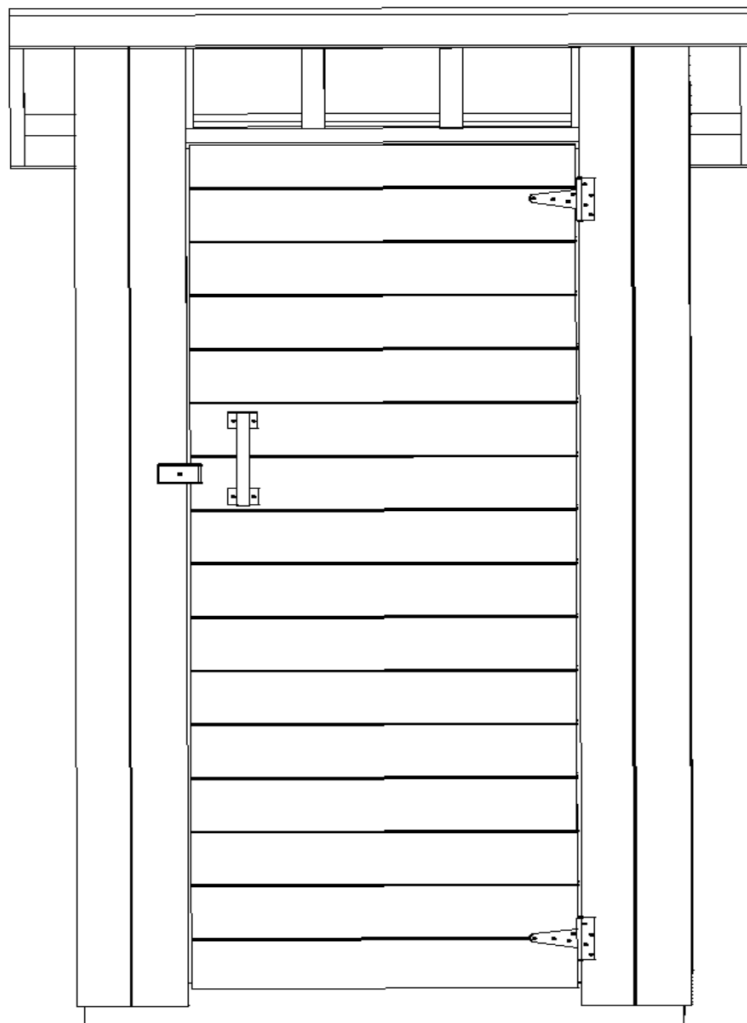

Kuva 9

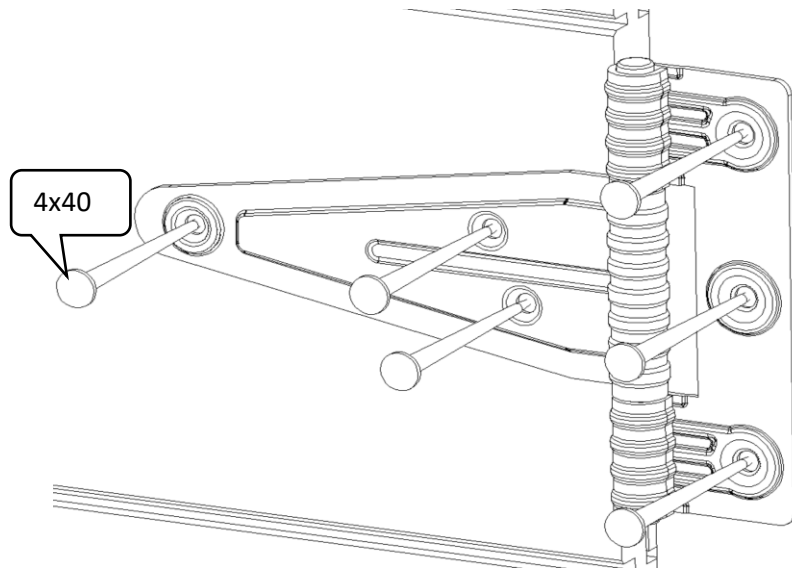

Kuva 10.1

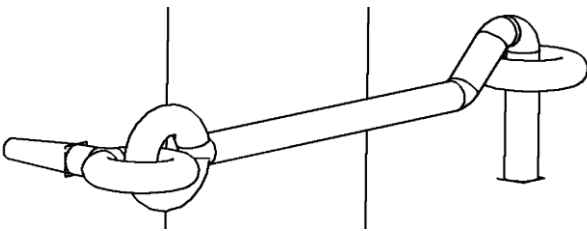

Kuva 10.2

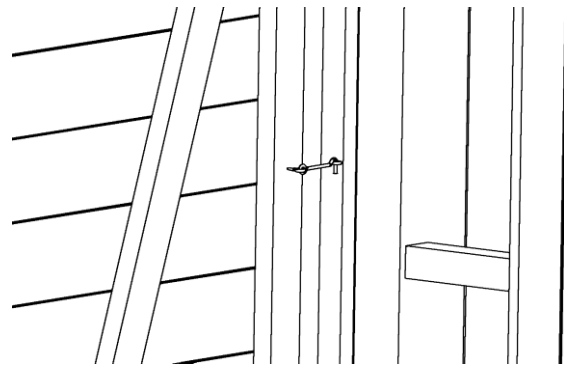

Kuva 10

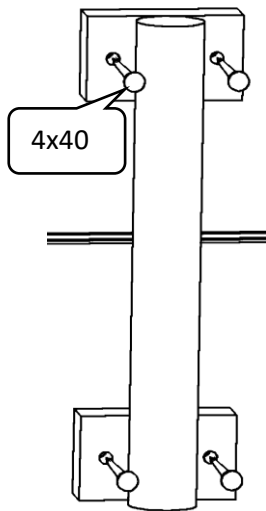

Kuva 11

