

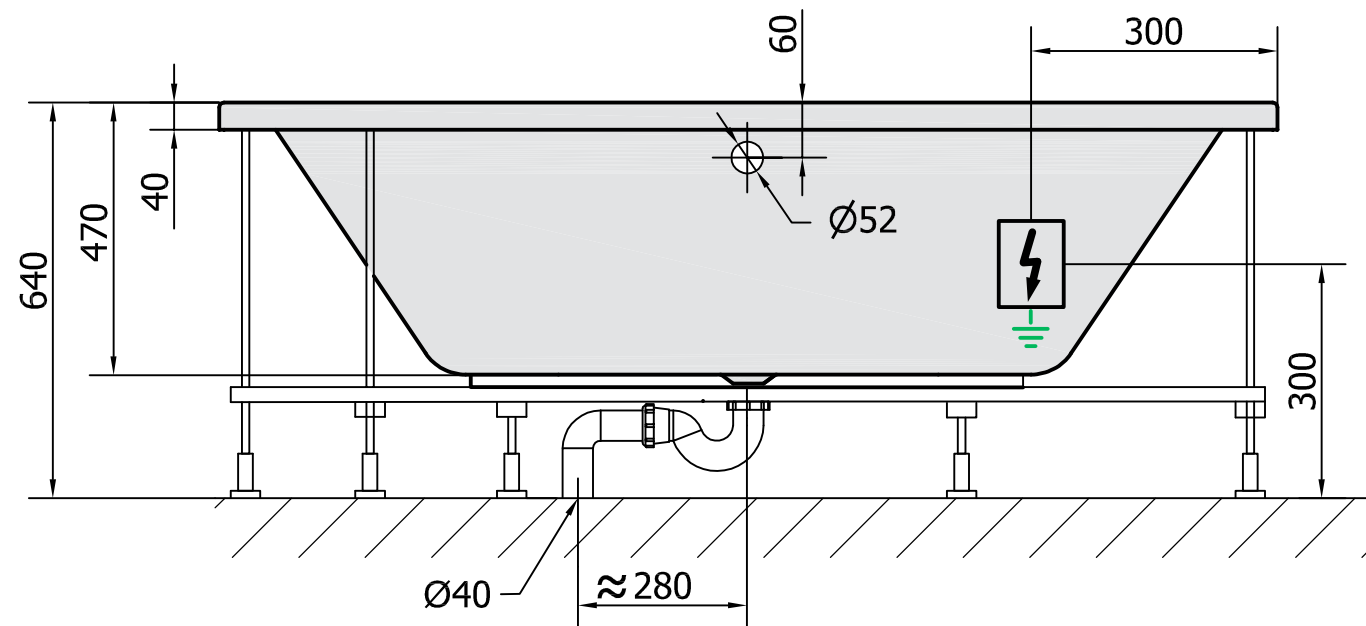

**H** HYDRO  
 12 whirlpool jets  
 12 vodních trysek



 Electric cable 3x2,5mm<sup>2</sup>  
 Length 2m from the wall  
 Elektrický kabel 3x2,5mm<sup>2</sup>  
 Délka kabelu ze zdi 2m

Electrical Characteristic:  
 Tension: 220-230V/50hz  
 Max. power consumption: 800W  
 Electric protection: residual-current device 30mA

Elektrické vlastnosti:  
 Napětí: 220-230V/50hz  
 Max. spotřeba: 800W  
 Elektrické jištění: proudový chránič 30mA

VOLUME 235L

Kreslil vs	Kontroloval	Schválil	Datum	Datum	
<b>polysan</b> 		78119H WHIRLPOOL BATH TUB			List
		VIVA175x80R			1 / 1