

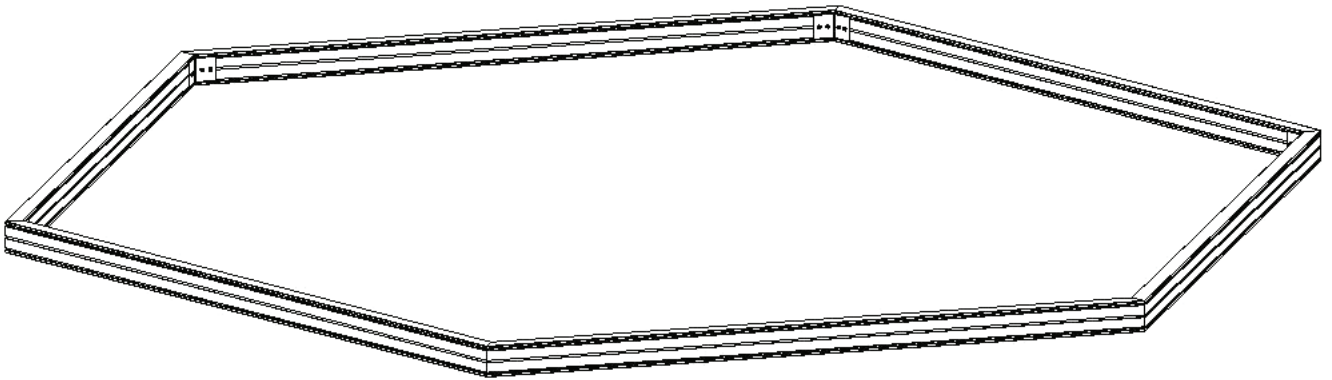









# Käyttöohje



MALLI: 142-2-48 Runko

LUE HUOLELLISESTI ENNEN ASENNUSTA

OSA	NRO	KPL
 1775,3 mm	DJ01	6
	DJW07	6
	DJW03	12
 Ø9XØ17x1	DJW04	12
	DJW05	12
 Ø5X40	DJZ01	12
 M6X10	S01	24
 M6	M01	36
 TSM6X12	S02	12

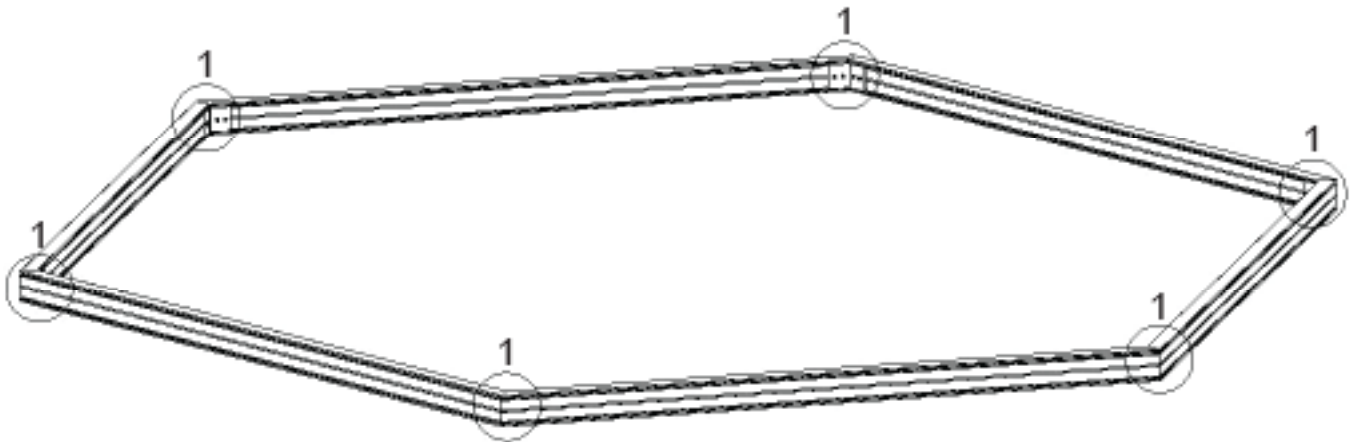

Kokoa 6 x DJ01 ja DJW07, kiinnitä ne ruuvilla S01 ja mutterilla M01.

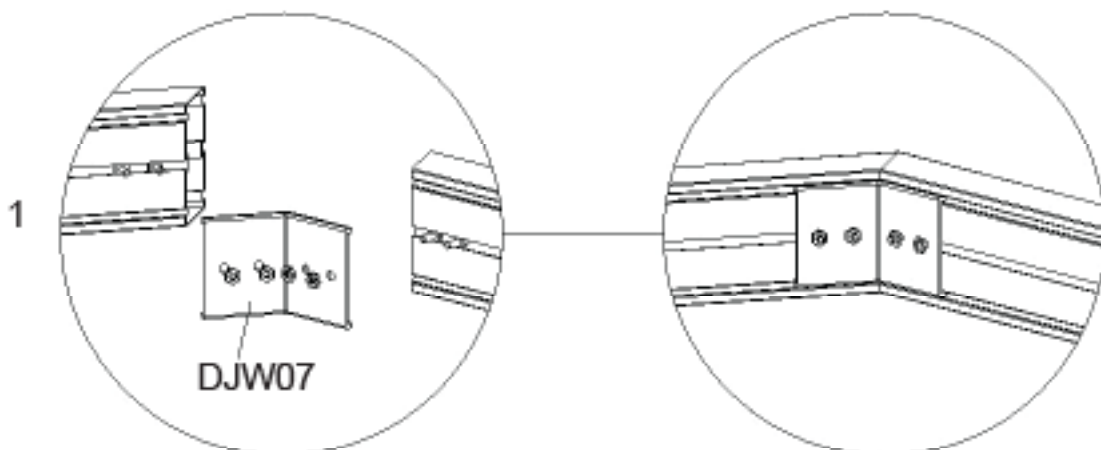

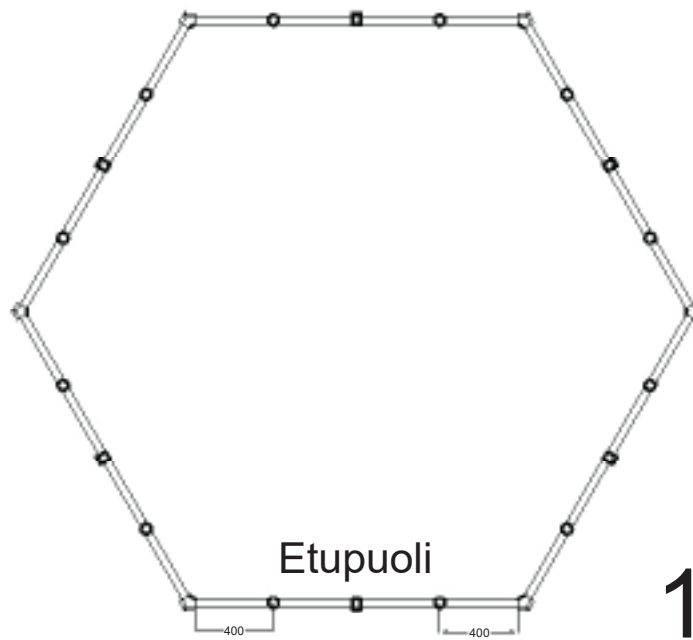

# 142-2-48

Aseta ensin sokkelit, liitännät ja kiinnityskannattimet karkeasti paikoilleen ja kiristä ne sitten mukana toimitetuilla ruuveilla ja muttereilla.

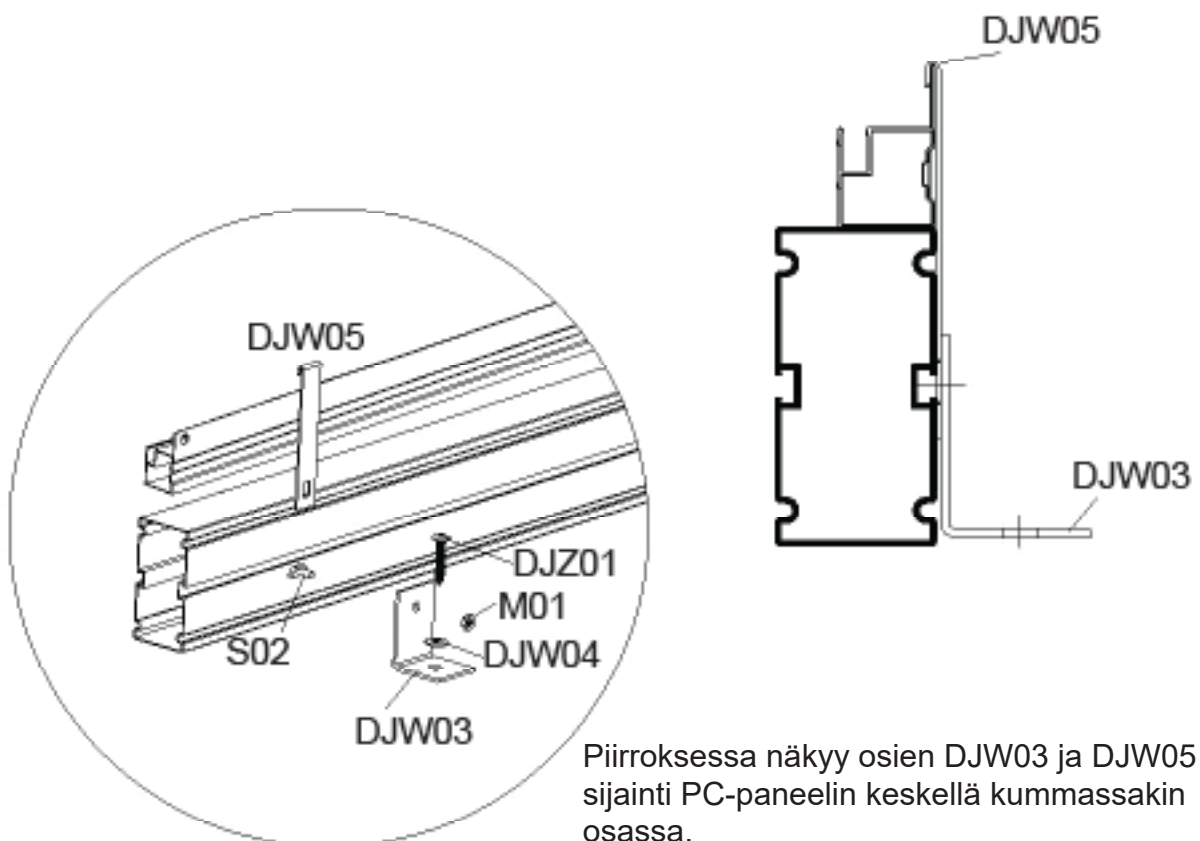

Piirroksessa näkyy osien DJW03 ja DJW05 sijainti PC-paneelin keskellä kummassakin osassa.

### Asiakaspalvelun yhteystiedot

Arc E-commerce AB  
 Box 3124  
 13603 Haninge  
 Ruotsi