

1

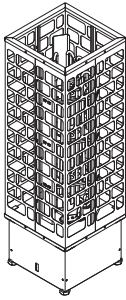

2

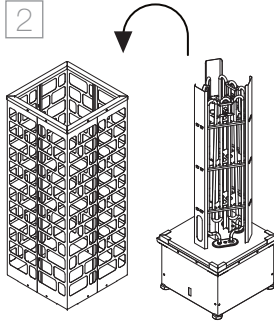

3

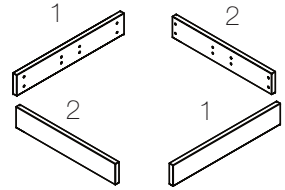

It is avisable to install the Guard Rail with the casing only.

Note on the parts' corresponding numbers

4

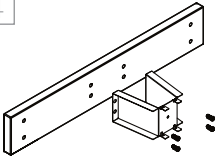

Assemble the wood and metal holder with screws.

5

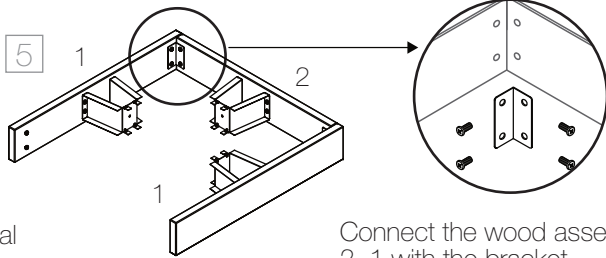

Connect the wood assembly 1, 2, 1 with the bracket.

6

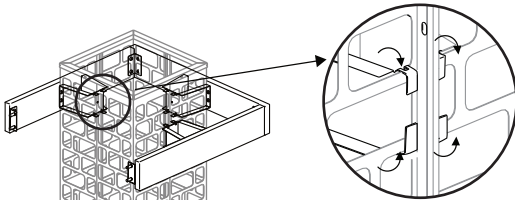

Bend the clips to secure.

Clip the metal holders into the casing.

7

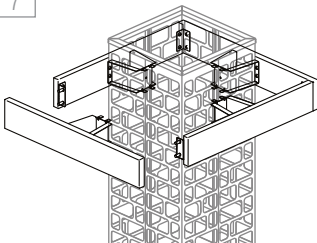

Attach last piece of wood assembly by following steps 6 and 5.

8

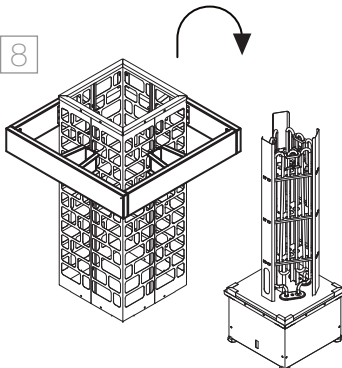

Return the casing with the guard rail into the heater assembly.

