















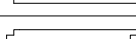

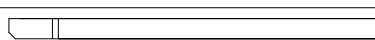
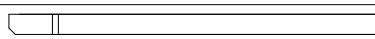
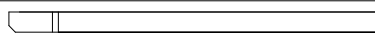
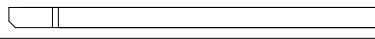
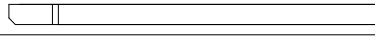
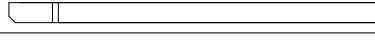
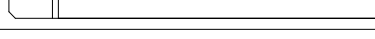
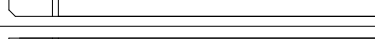
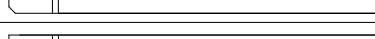
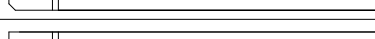
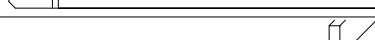
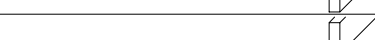











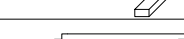

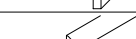











Packaging list - Toronto 4 420x660cm (Basic kit) -

621767

Description	amount	packed	actual state
Fitting set 	1		
Floor beam 58x58x1925mm 	6		
Floor beam 58x58x3964mm 	5		
Floor beam 58x113x2260mm 	1		
Floor beam 58x113x2430mm 	2		
Floor beam 58x113x3964mm 	3		
Floor beam 58x113x4160mm 	2		
Floor boarding with tongue and groove, 19mm, 2320mm 	36		
Floor boarding with tongue and groove, 19mm, 4050mm 	57		
Floorslat 19x58x3000mm 	16		
Purlin Pos. 1 70x180x2790mm 	1		
Purlin Pos. 2 70x180x2830mm 	1		
Purlin Pos. 3 70x180x2790mm 	1		
Purlin Pos. 4 70x180x2830mm 	1		
Purlin Pos. 5 70x180x2790mm 	1		
Purlin Pos. 6 70x180x2830mm 	1		
Purlin Pos. 7 70x180x4610mm 	1		
Purlin Pos. 8 70x180x4570mm 	1		
Purlin Pos. 9 70x180x4610mm 	1		
Purlin Pos. 10 70x180x4570mm 	1		
Purlin Pos. 11 70x180x4610mm 	1		
Purlin Pos. 12 70x180x4570mm 	1		
Roof beam support 19x120x450mm 	2		
Roof beam support 19x120x930mm 	1		
Double window with double-glazing 1265x780mm 	2		
Single window with double-glazing 520x1180mm , left 	1		
Single window with double-glazing 520x1180mm , right 	2		
Double door with double-glazing 1420x1960mm 	1		
Inside door 810x1950mm 	2		
Slat for inside door 19x120x1090mm 	4		
Slat for inside door 19x80x1970mm 	8		
T-slat for window reveal 875mm 	4		
T-slat for window reveal 1215mm 	2		
T-slat for window reveal 1280mm 	4		
T-slat for door reveal 2025mm 	6		
Threshold for inside door 28x70x890mm 	2		
Roof boarding with tongue and groove, 28mm, 1025mm 	130		
Roof boarding with tongue and groove, 28mm, 1840mm 	130		
Slat under roof boarding 25x55x3700mm 	4		
Gable slat / Slat for roof boarding 20x20x1000mm 	12		
Slat for roof boarding 20x20x2000mm 	4		
Gable slat 20x20x1400mm 	8		
Eaves slat 16x58x3700mm 	4		
Gable slat 28x140x3020mm 	4		
Top slat 16x58x3020mm 	4		
Aluminium slat for top slat 2000mm	8		

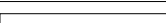
Packaging list - Toronto 4 420x660cm (Basic kit) -

















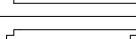

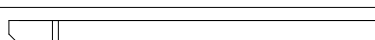
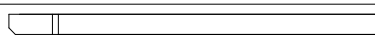
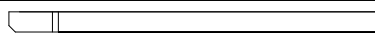
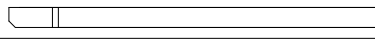
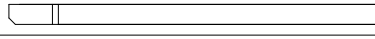
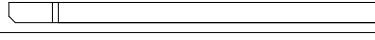
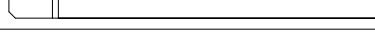
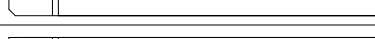
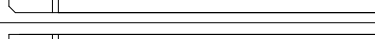
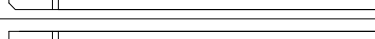

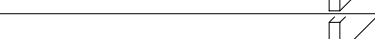







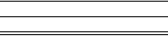
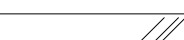
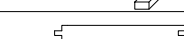

621767

Description	amount	packed			actual state
Decoration for gable 20x120x200mm 	2				
Post for purlin 120x120x463mm 	2				
Post for purlin 120x120x944mm 	1				
Supporting for beam for storage area 40x58x1995mm 	4				
Beam for storage area 70x70x2330mm 	8				
Longitudinal strut for roof constuction 19x120x4060mm 	4				
Connecting piece for roof construction 43x120x200mm 	8				
Vertical strut for roof construction 43x120x1102mm 	2				
Angularly strut for roof construction 43x120x1067mm 	4				
Steel bar 2500mm 	6				
Tarpaper in roll, length 7400mm 	7				
Piece of wood for assembly 300mm 	2				

packed:











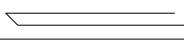
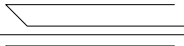
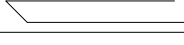

Packaging list - Toronto 4 420x660cm (Kit for tiles) -

621774

Description	amount	packed	actual state
Fitting set 	1		
Floor beam 58x58x1925mm 	6		
Floor beam 58x58x3964mm 	5		
Floor beam 58x113x2260mm 	1		
Floor beam 58x113x2430mm 	2		
Floor beam 58x113x3964mm 	3		
Floor beam 58x113x4160mm 	2		
Floor boarding with tongue and groove, 28mm, 2320mm 	36		
Floor boarding with tongue and groove, 28mm, 4050mm 	57		
Floorslat 19x58x3000mm 	16		
Purlin Pos. 1 70x180x2790mm 	1		
Purlin Pos. 2 70x180x2830mm 	1		
Purlin Pos. 3 70x180x2790mm 	1		
Purlin Pos. 4 70x180x2830mm 	1		
Purlin Pos. 5 70x180x2790mm 	1		
Purlin Pos. 6 70x180x2830mm 	1		
Purlin Pos. 7 70x180x4610mm 	1		
Purlin Pos. 8 70x180x4570mm 	1		
Purlin Pos. 9 70x180x4610mm 	1		
Purlin Pos. 10 70x180x4570mm 	1		
Purlin Pos. 11 70x180x4610mm 	1		
Purlin Pos. 12 70x180x4570mm 	1		
Roof beam support 19x120x450mm 	2		
Roof beam support 19x120x930mm 	1		
Rafter 43x120x2940mm 	16		
Squared timber between rafter 43x120x1008mm 	14		
Slat for rafter 19x43x2940mm 	16		
Double window with double-glazing 1265x780mm 	2		
Single window with double-glazing 520x1180mm , left 	1		
Single window with double-glazing 520x1180mm , right 	2		
Double door with double-glazing 1420x1960mm 	1		
Inside door 810x1950mm 	2		
Slat for inside door 19x120x1090mm 	4		
Slat for inside door 19x80x1970mm 	8		
T-slat for window reveal 875mm 	4		
T-slat for window reveal 1215mm 	2		
T-slat for window reveal 1280mm 	4		
T-slat for door reveal 2025mm 	6		
Threshold for inside door 28x70x890mm 	2		
Roof boarding with tongue and groove, 19mm, 1025mm 	136		
Roof boarding with tongue and groove, 19mm, 1840mm 	136		
Slat under roof boarding 25x55x3700mm 	4		
Roof batten 40x58x3175mm 	22		
Roof batten 40x58x4225mm 	22		
Gable slat 20x20x1000mm 	8		
Gable slat 20x20x1400mm	8		

Packaging list - Toronto 4 420x660cm (Kit for tiles) -

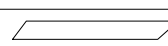
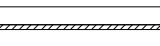
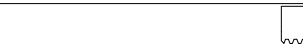















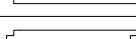

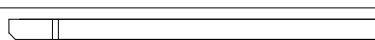
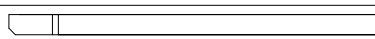

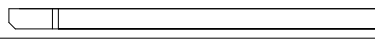
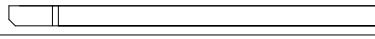
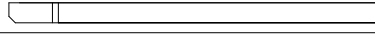
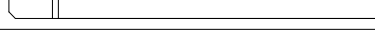
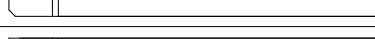
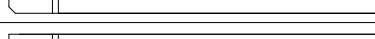
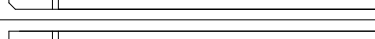









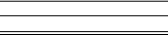

621774

Description	amount	packed			actual state
Eaves slat 28x140x3175mm 	4				
Eaves slat 28x140x4225mm 	4				
Gable slat 28x70x3120mm 	4				
Gable slat 28x140x3120mm 	4				
Gable slat 28x140x3080mm 	4				
Decoration for gable 20x120x200mm 	2				
Post for purlin 120x120x463mm 	2				
Post for purlin 120x120x944mm 	1				
Supporting for beam for storage area 40x58x1995mm 	4				
Beam for storage area 70x70x2330mm 	8				
Longitudinal strut for roof constuction 19x120x4060mm 	4				
Connecting piece for roof construction 43x120x200mm 	8				
Vertical strut for roof construction 43x120x1102mm 	2				
Angularly strut for roof construction 43x120x1067mm 	4				
Steel bar 2500mm 	6				
Piece of wood for assembly 300mm 	2				

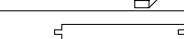
packed:

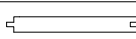
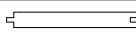

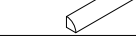











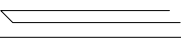
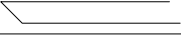
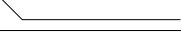



Packaging list - Toronto 4 420x660cm (Kit for shingles) -

621781

Description	amount	packed	actual state
Fitting set 	1		
Floor beam 58x58x1925mm 	6		
Floor beam 58x58x3964mm 	5		
Floor beam 58x113x2260mm 	1		
Floor beam 58x113x2430mm 	2		
Floor beam 58x113x3964mm 	3		
Floor beam 58x113x4160mm 	2		
Floor boarding with tongue and groove, 19mm, 2320mm 	36		
Floor boarding with tongue and groove, 19mm, 4050mm 	57		
Floorslat 19x58x3000mm 	16		
Purlin Pos. 1 70x180x2790mm 	1		
Purlin Pos. 2 70x180x2830mm 	1		
Purlin Pos. 3 70x180x2790mm 	1		
Purlin Pos. 4 70x180x2830mm 	1		
Purlin Pos. 5 70x180x2790mm 	1		
Purlin Pos. 6 70x180x2830mm 	1		
Purlin Pos. 7 70x180x4610mm 	1		
Purlin Pos. 8 70x180x4570mm 	1		
Purlin Pos. 9 70x180x4610mm 	1		
Purlin Pos. 10 70x180x4570mm 	1		
Purlin Pos. 11 70x180x4610mm 	1		
Purlin Pos. 12 70x180x4570mm 	1		
Roof beam support 19x120x450mm 	2		
Roof beam support 19x120x930mm 	1		
Rafter 43x120x2940mm 	16		
Squared timber between rafter 43x120x1008mm 	14		
Slat for rafter 19x43x2940mm 	16		
Double window with double-glazing 1265x780mm 	2		
Single window with double-glazing 520x1180mm , left 	1		
Single window with double-glazing 520x1180mm , right 	2		
Double door with double-glazing 1420x1960mm 	1		
Inside door 810x1950mm 	2		
Slat for inside door 19x120x1090mm 	4		
Slat for inside door 19x80x1970mm 	8		
T-slat for window reveal 875mm 	4		
T-slat for window reveal 1215mm 	2		
T-slat for window reveal 1280mm 	4		
T-Leiste für Türleibung 2025mm 	6		
Threshold for inside door 28x70x890mm 	2		
Roof boarding with tongue and groove, 19mm, 1025mm 	136		
Roof boarding with tongue and groove, 19mm, 1840mm 	136		
Slat under roof boarding 25x55x3700mm 	4		
Roof boarding with tongue and groove, 19mm, 3175mm 	52		
Roof boarding with tongue and groove, 19mm, 4225mm 	52		
Gable slat 20x20x1000mm 	8		
Gable slat 20x20x1400mm	8		

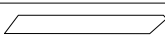
Packaging list - Toronto 4 420x660cm (Kit for shingles) -

621781

Description	amount	packed			actual state
Eaves slat 28x70x3175mm 	2				
Eaves slat 28x140x3175mm 	2				
Eaves slat 28x70x4225mm 	2				
Eaves slat 28x140x4225mm 	2				
Gable slat 28x70x3120mm 	4				
Gable slat 28x140x3120mm 	4				
Gable slat 28x140x3080mm 	4				
Top slat 16x58x3120mm 	4				
Aluminium slat for top slat 2000mm 	8				
Decoration for gable 20x120x200mm 	2				
Post for purlin 120x120x463mm 	2				
Post for purlin 120x120x944mm 	1				
Supporting for beam for storage area 40x58x1995mm 	4				
Beam for storage area 70x70x2330mm 	8				
Longitudinal strut for roof constuction 19x120x4060mm 	4				
Connecting piece for roof construction 43x120x200mm 	8				
Vertical strut for roof construction 43x120x1102mm 	2				
Angularly strut for roof construction 43x120x1067mm 	4				
Steel bar (10mm) 2500mm 	6				
Tarpaper in roll, length 7400mm 	7				
Piece of wood for assembly 300mm 	2				

packed: