

Tapwell

TW1500-85
Towel warmer



MOUNTING INSTRUCTIONS



**IMPORTANT- These instructions are for your safety.
Please read through them thoroughly prior to
handling the product and retain them
for future reference**

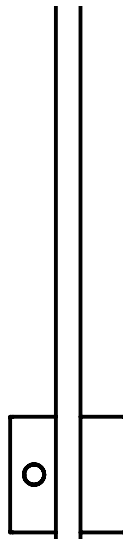

Tapwell

Content:

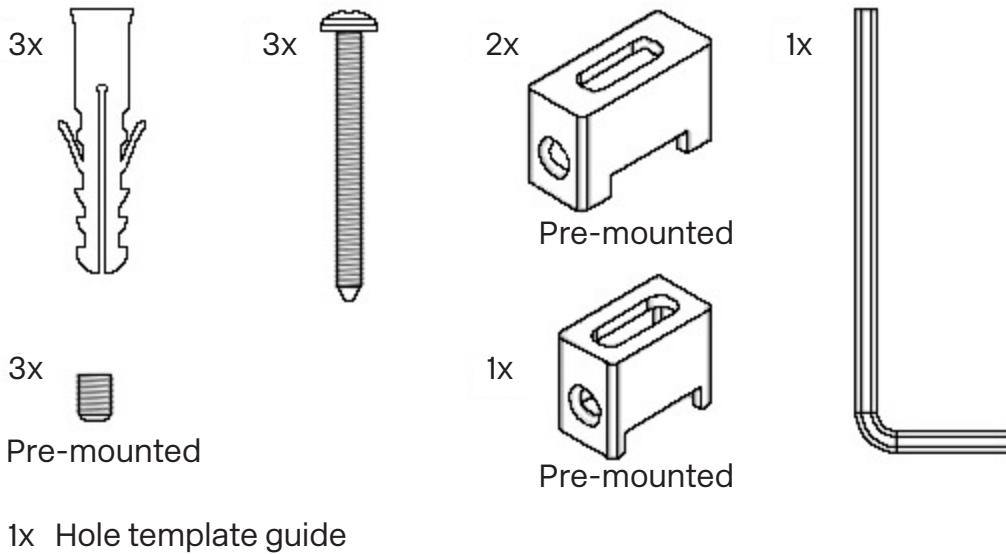

You need:

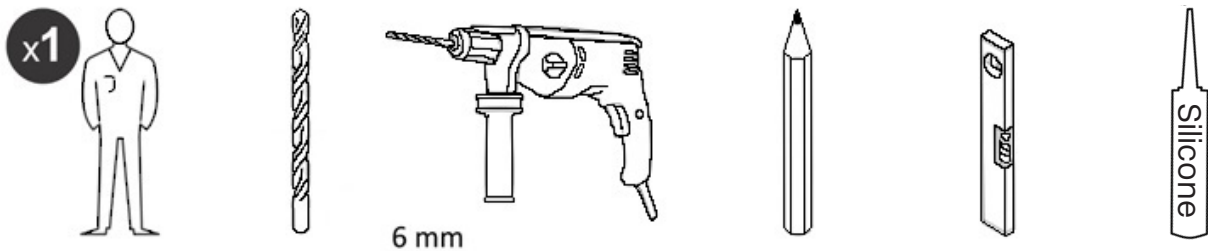

Cleaning and maintenance

Wipe the surface clean with a soft, damp cloth. Never use solvents, abrasives, bleaches, acids, strong detergents, aggressive chemical cleaners or solvent-type cleaning solutions on the product. On brushed surfaces, wipe in the same direction as the surface lines.

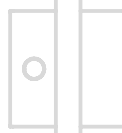

Tapwell

Safety:

IMPORTANT - the product shall always be installed by authorized electrician.

When using electrical appliances, to reduce the risk of fire, electric shock, and injury, one should always follow the basic precautions, which include:

- Read all instructions before using the product.
- This product is hot during use. To avoid burns, do not let your bare skin come into contact with hot surfaces.
- Extreme care should be taken when the product is used near children and leaving it unattended.
- If special precautions need to be taken during the installation of the device, appropriate details should be given.
- Keep the product clean.
- Use the product only as specified in this manual. Using the device other than the manufacturer's instructions may result in fire, electric shock, or personal injury.
- In order to avoid any hazard, if the power cord is damaged, it must be replaced by the manufacturer, the manufacturer's service centre or a similarly licensed person.

Proper disposal of this product

This marking indicates that this product should not be disposed of with other household waste in EU countries. To recycle your used device, please use the recycling or collection systems.

How it works

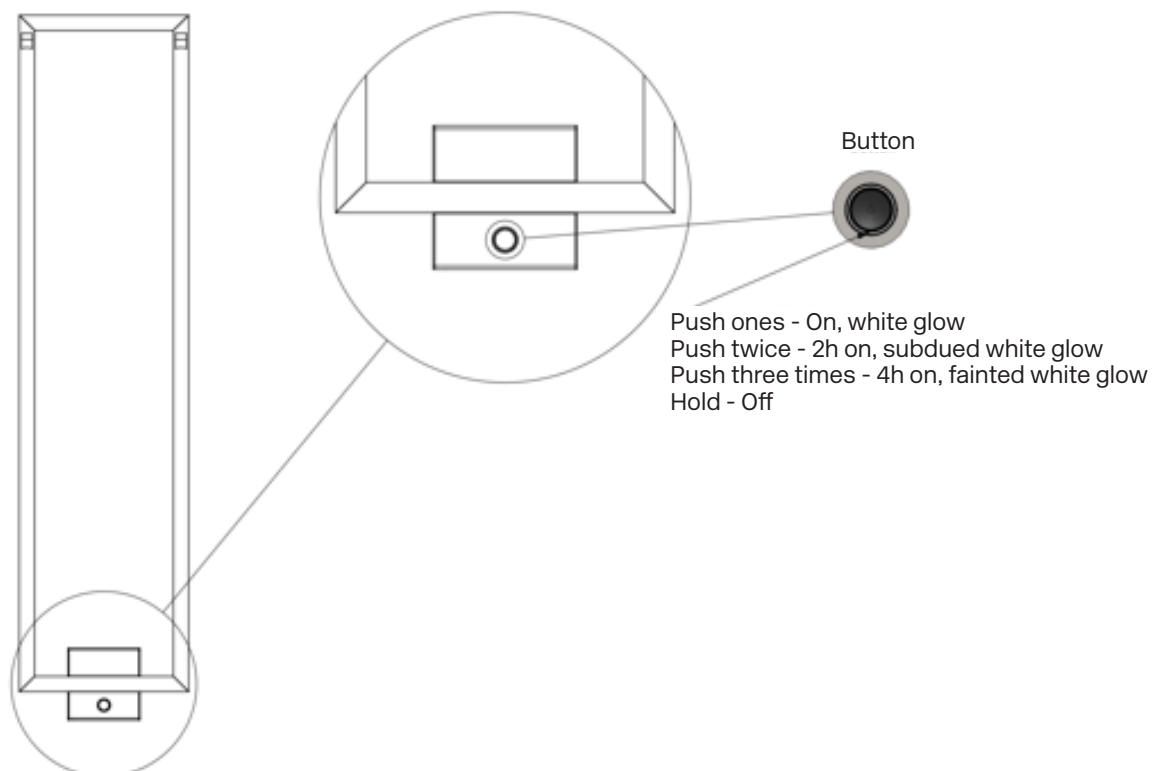

Tapwell

01 Recommended Mounting Height

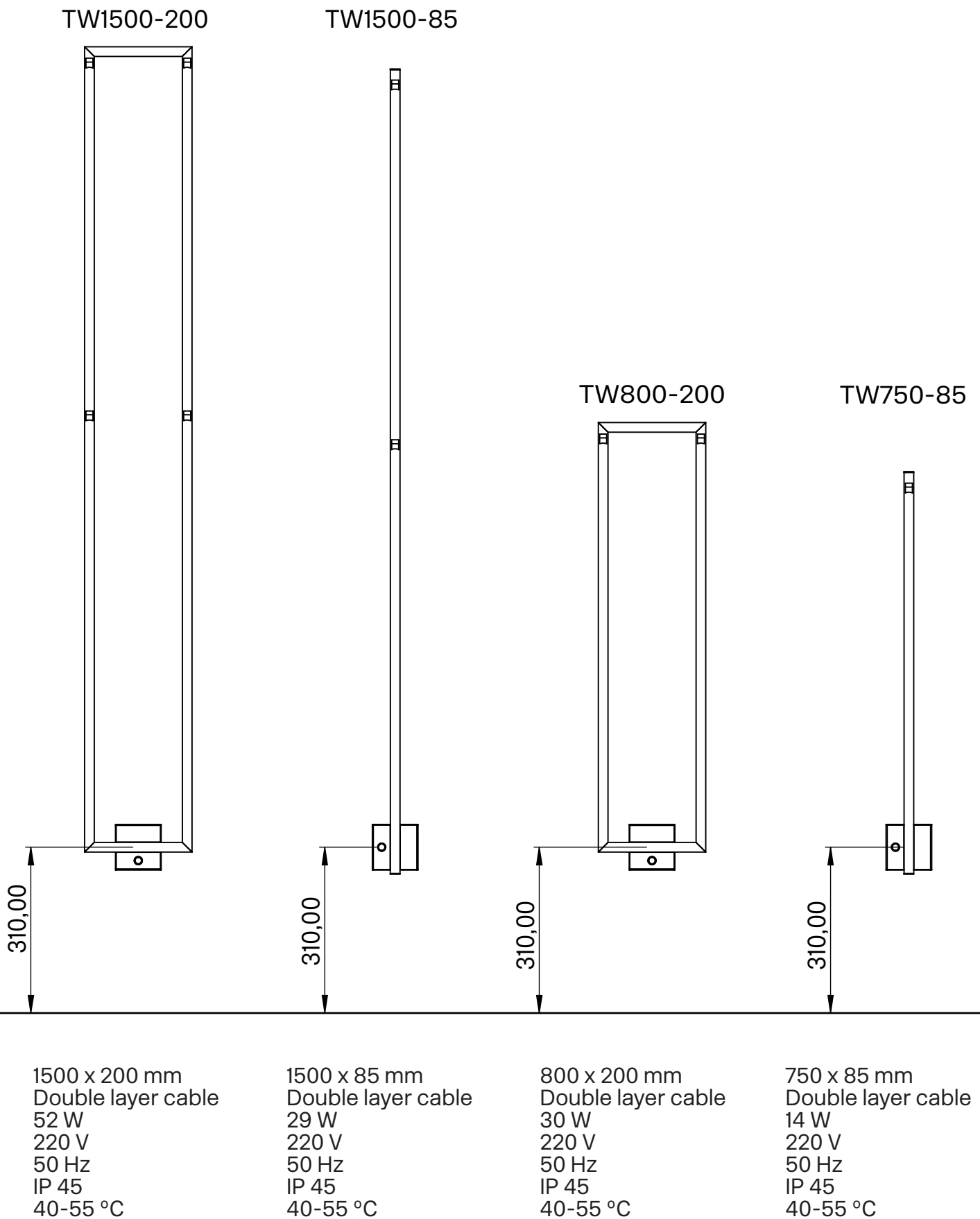

IMPORTANT - to be installed in appliance box

Tapwell

01 Recommended Mounting Height

TW800-400

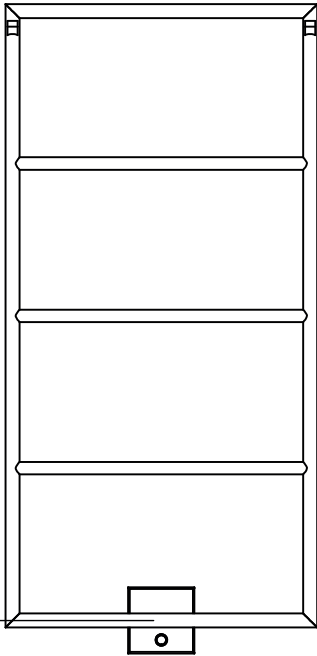

968,00

TW400-800

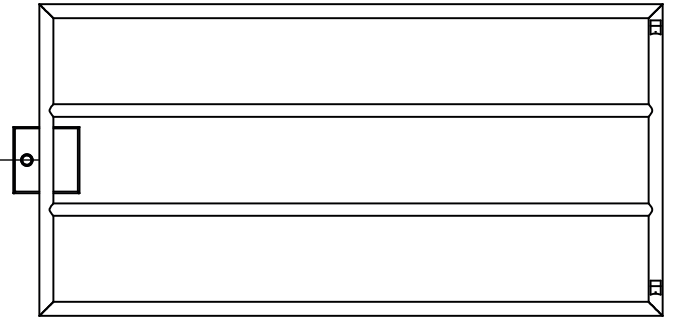

1450,00

800 x 400 mm
Double layer cable
68 W
220 V
50 Hz
IP 45
40-55 °C

400 x 800 mm
Double layer cable
78 W
220 V
50 Hz
IP 45
40-55 °C

IMPORTANT - to be installed in appliance box

Tapwell

02 Hole measurements (also see attached template guide)

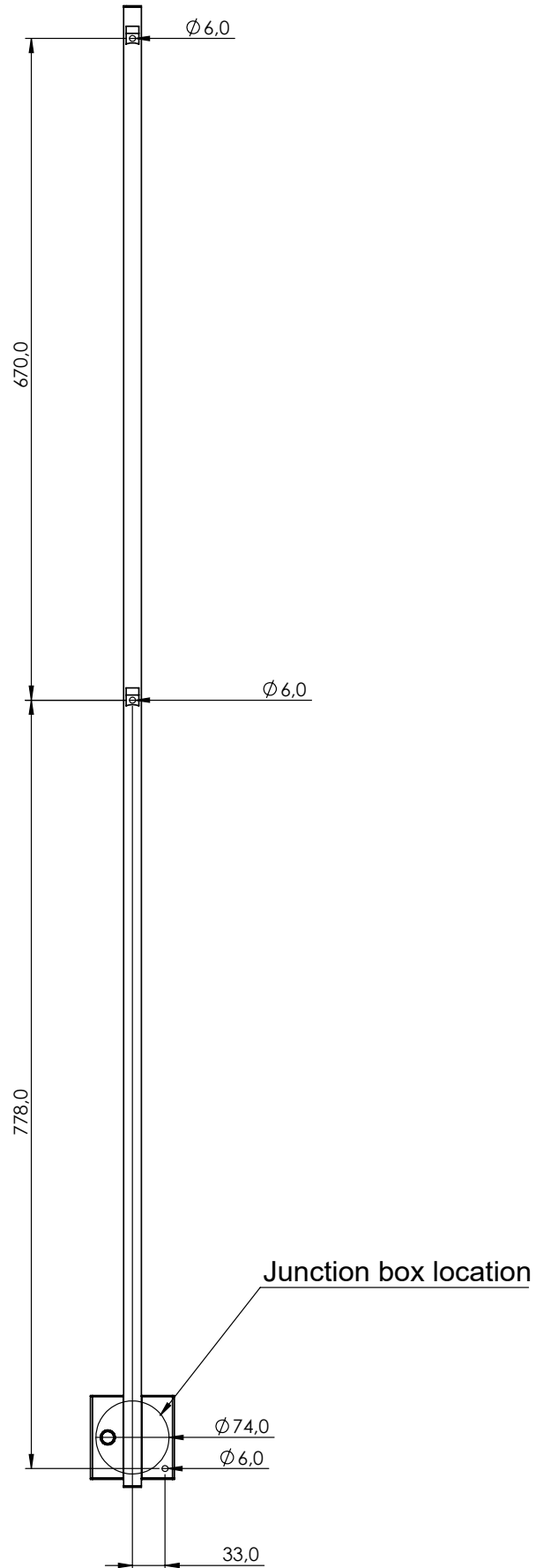

Tapwell

03 Separate pre-mounted screws and plastic mounts

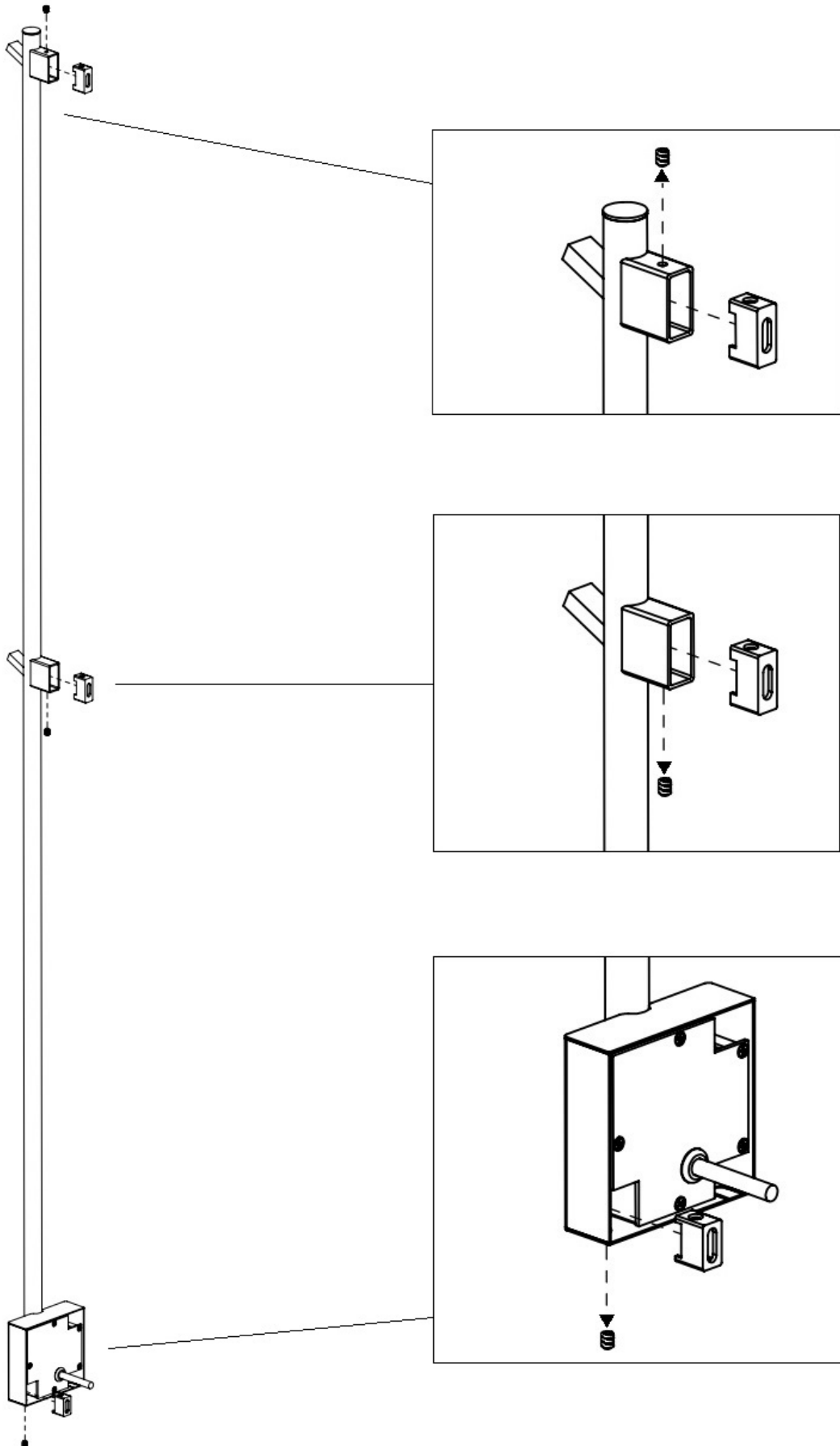

Tapwell

- This product is a dry type heater, it does not contain any liquid.
- Children under the age of 3 should be kept away from the product unless they are under constant supervision. Children aged 3 to 8 years may only switch the appliance on or off when it's placed or installed in its normal operating position if they have been given supervision or instruction concerning use of the appliance in a safe way and understand the hazards involved.

04

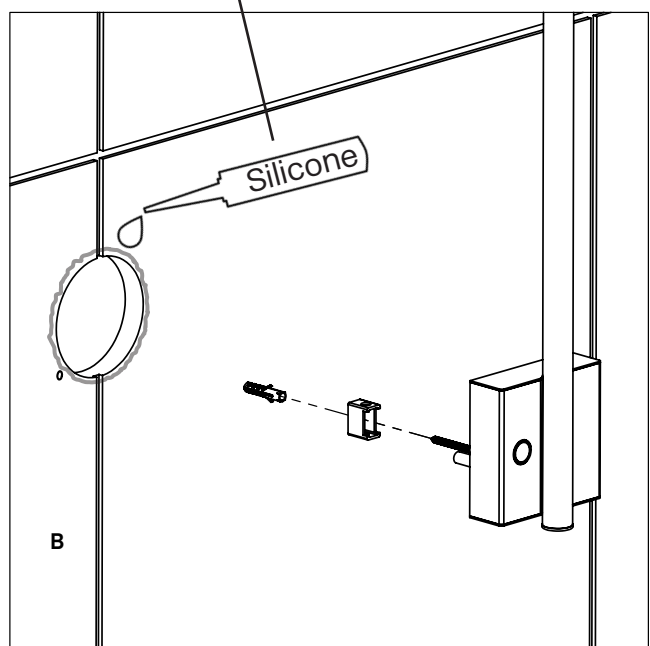
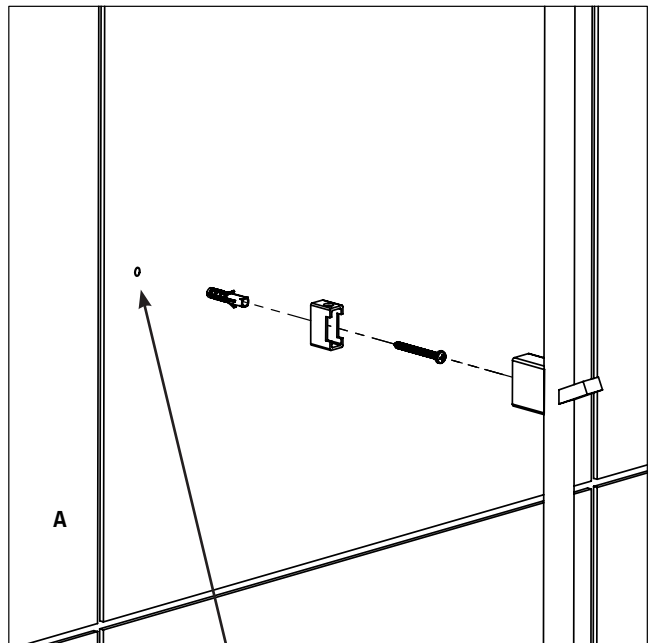
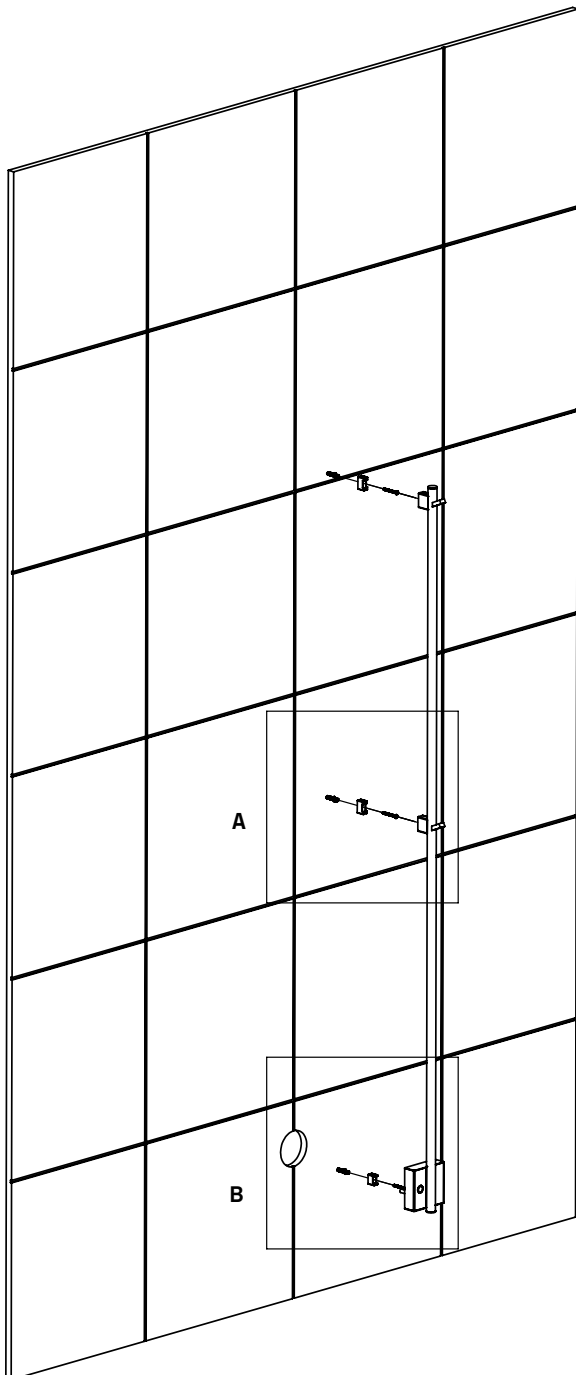

IMPORTANT - apply silicone in holes for the screws and around the hole for On/Off-box.