

# PERTTI 70

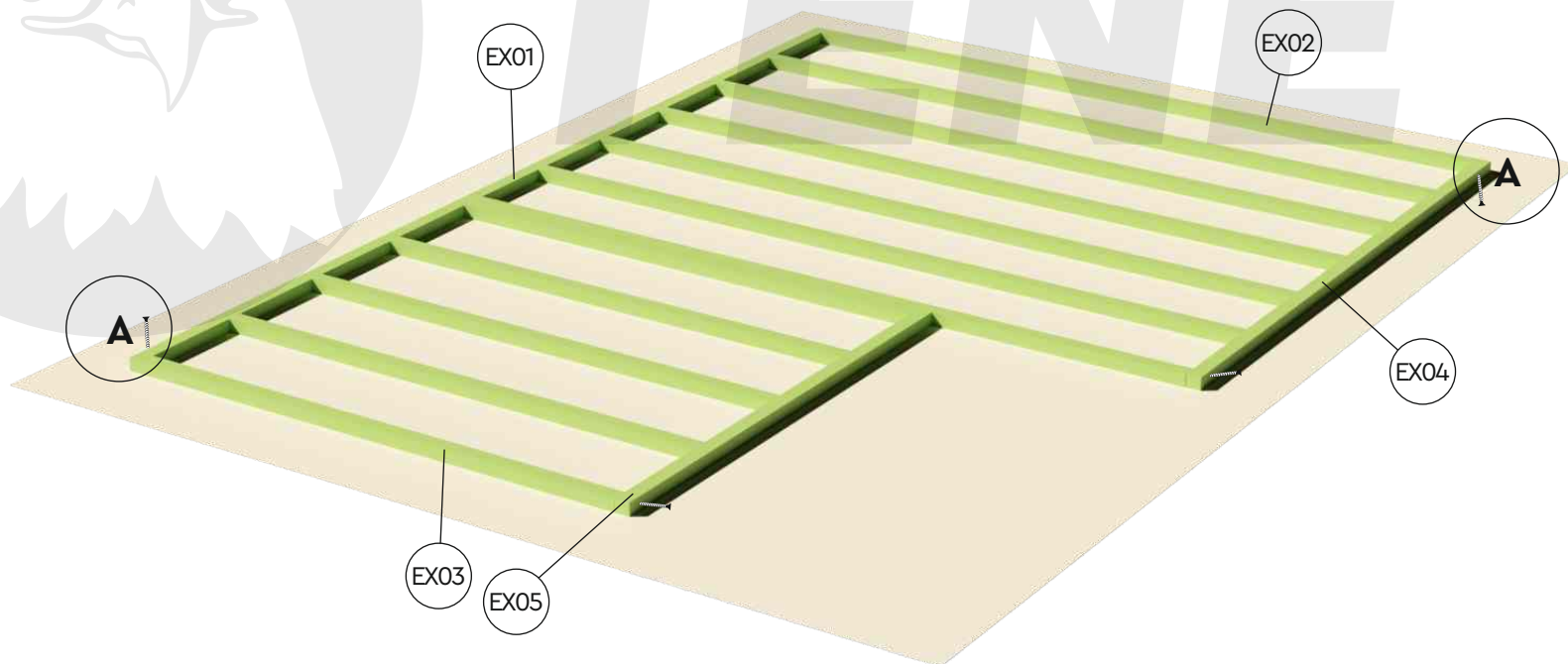

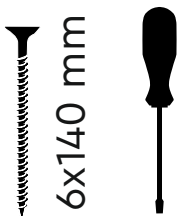

PERTTI 70

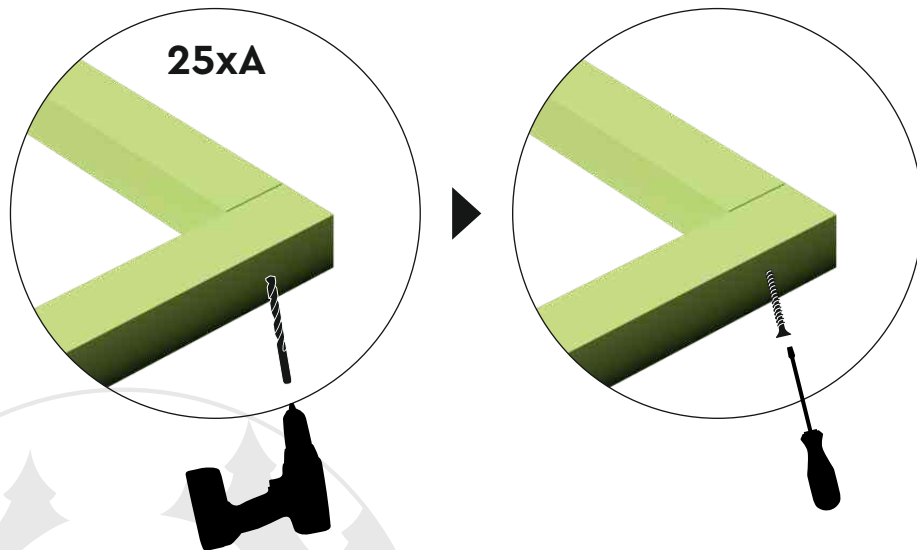
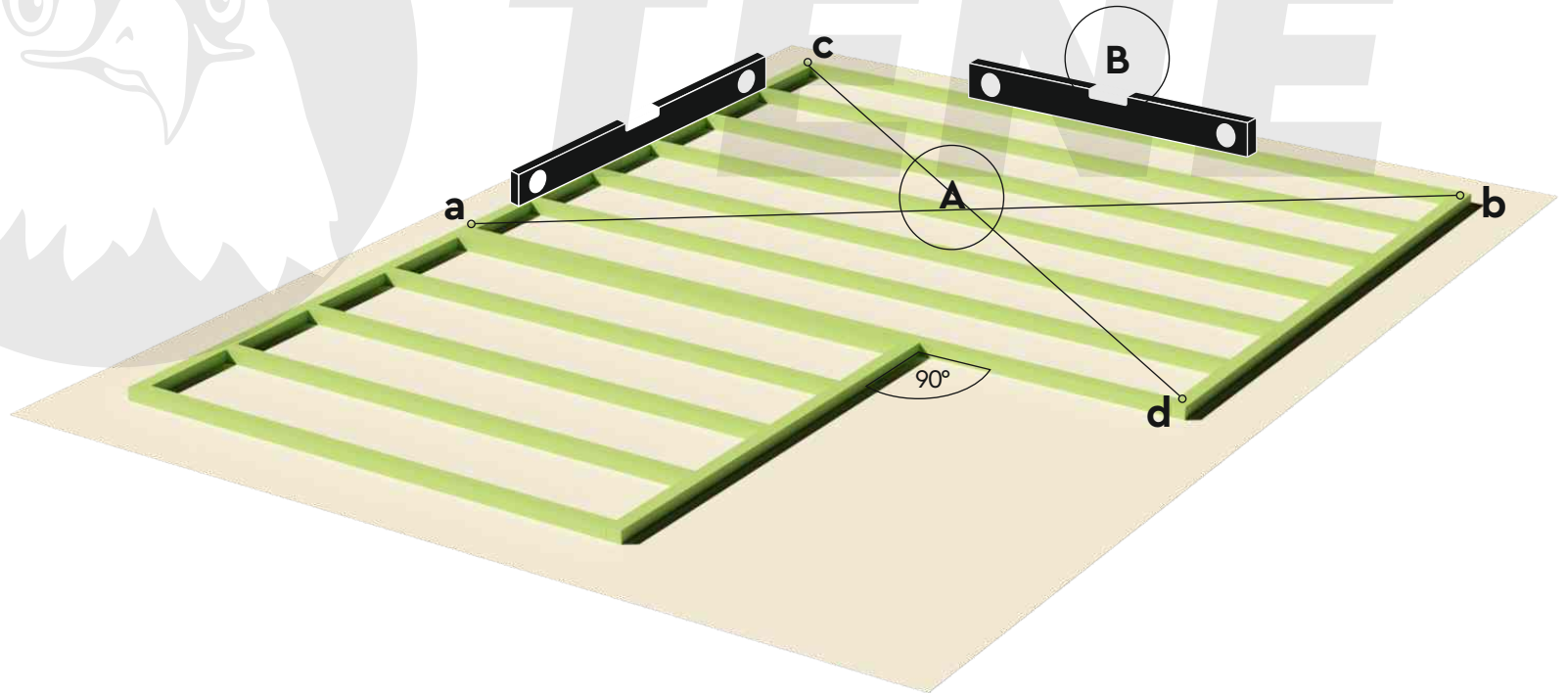
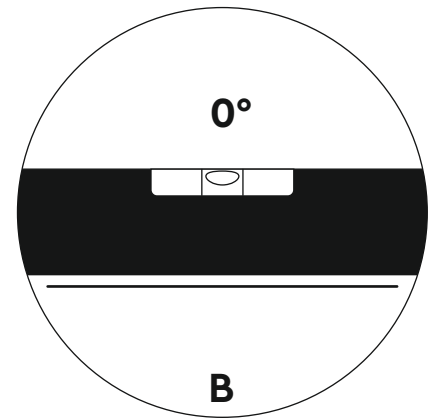
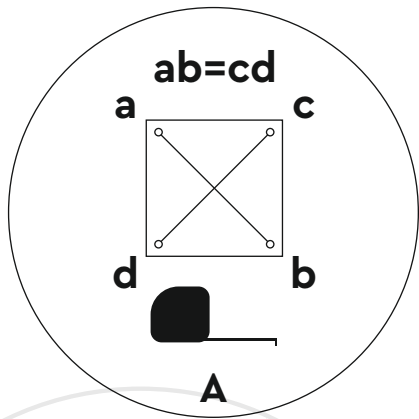
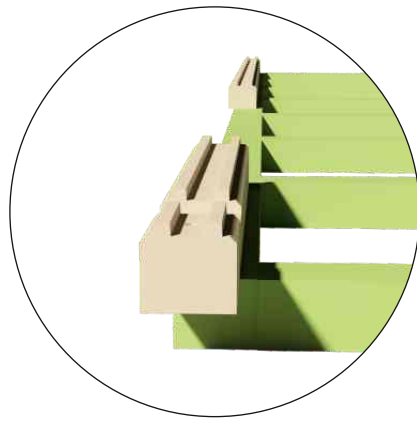
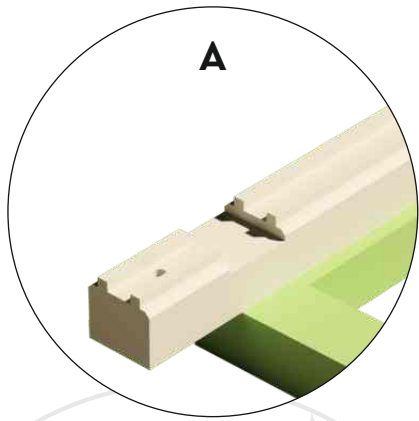

TENNE

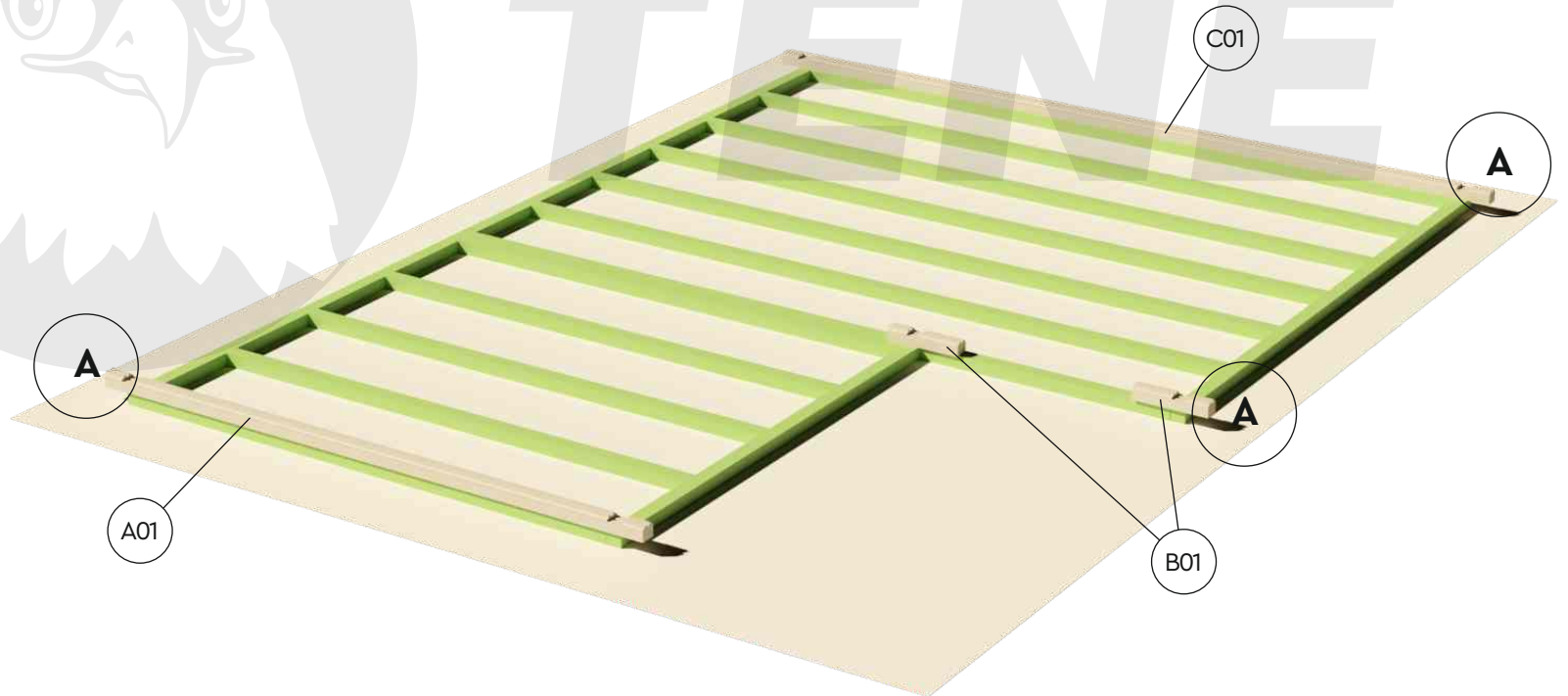



# PERTTI 70

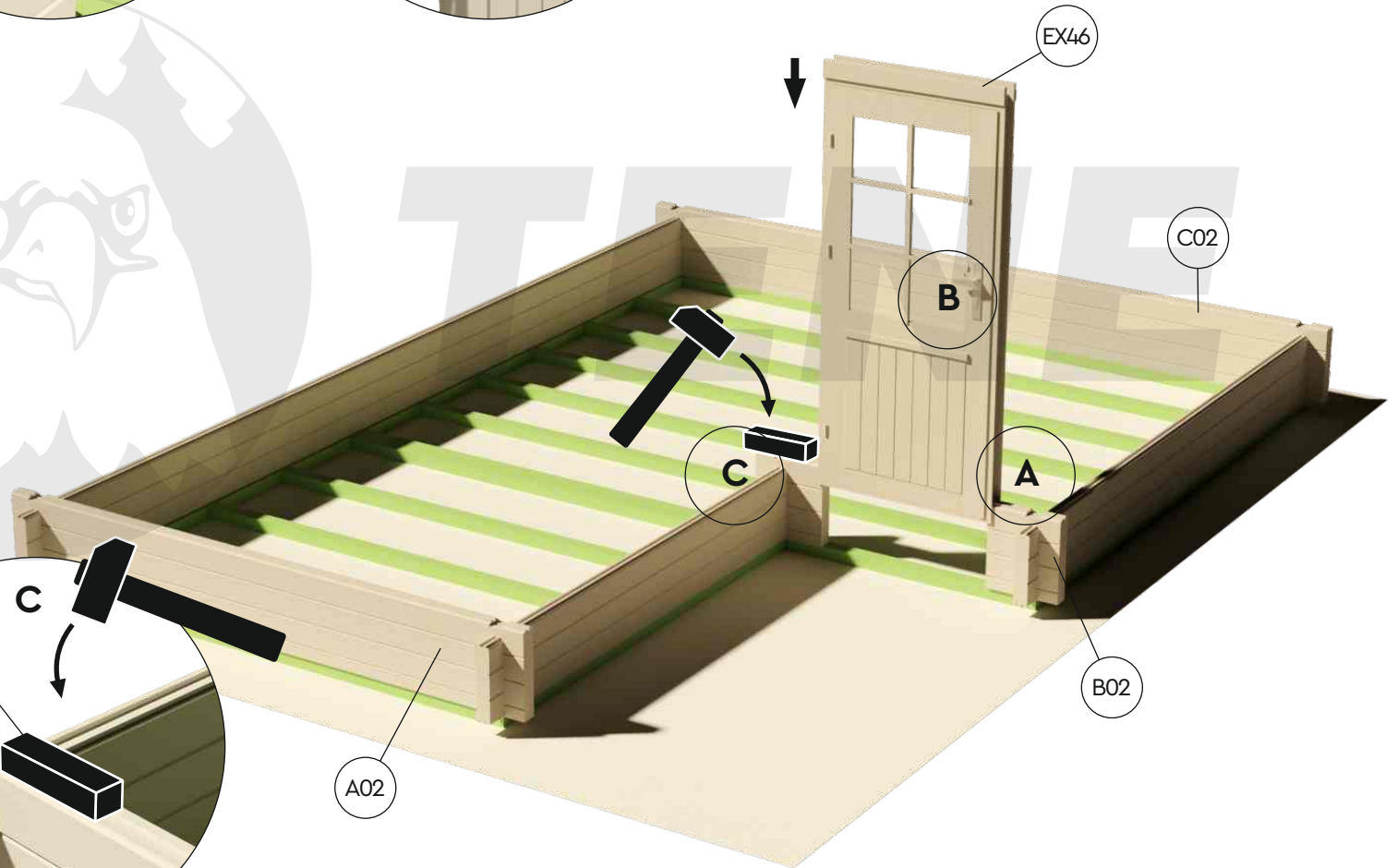
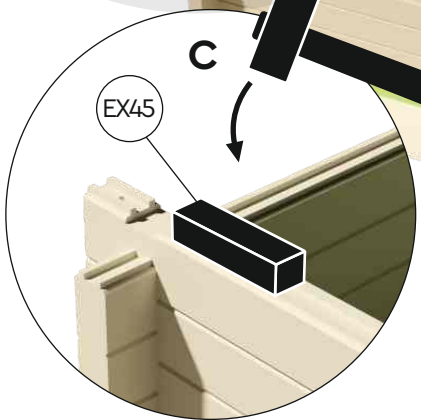
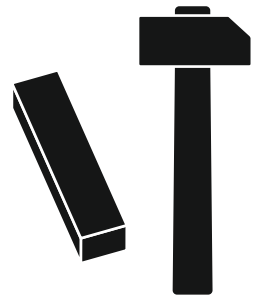
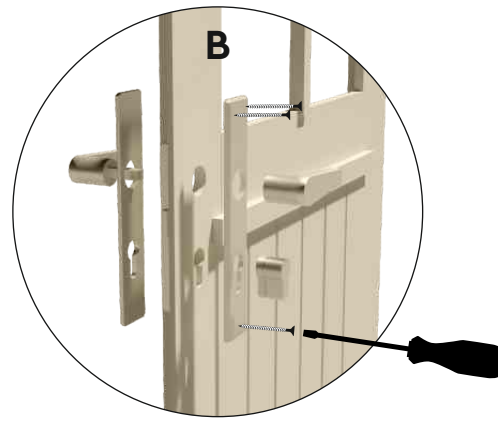
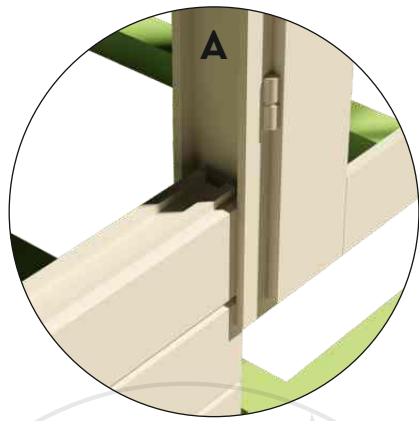

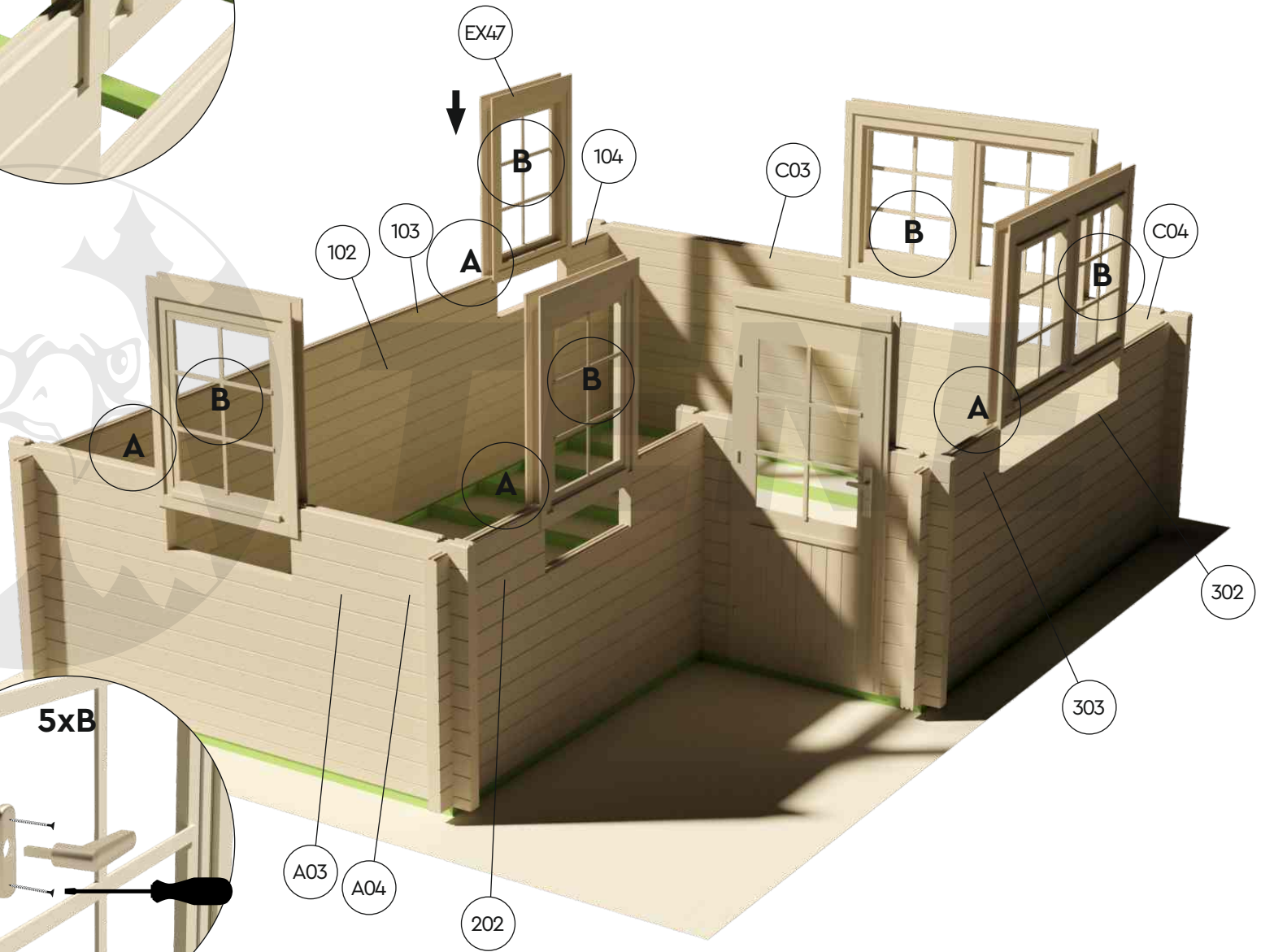
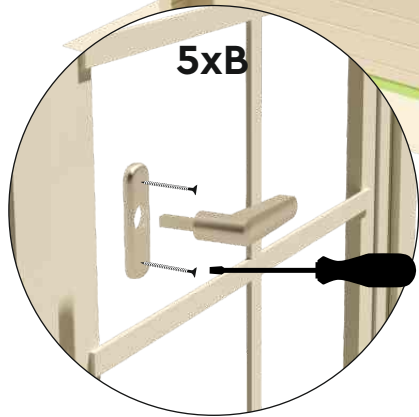
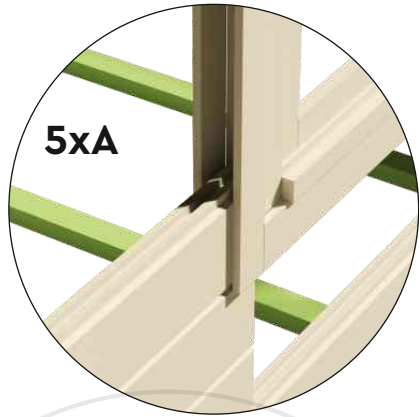
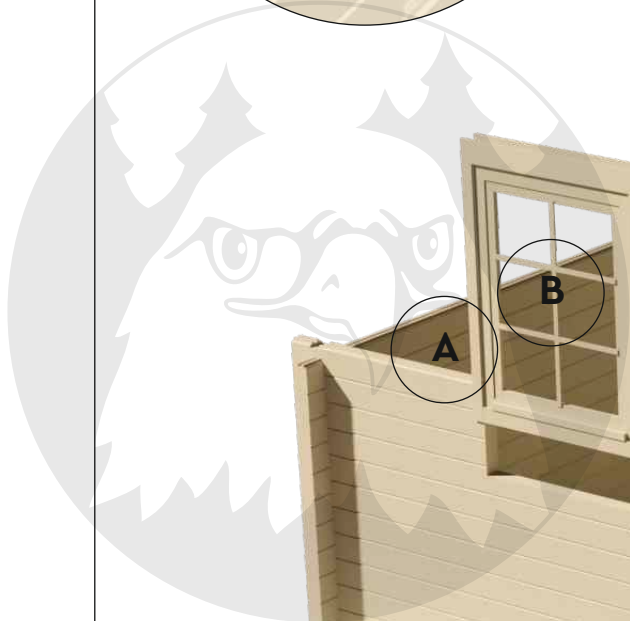

# PERTTI 70

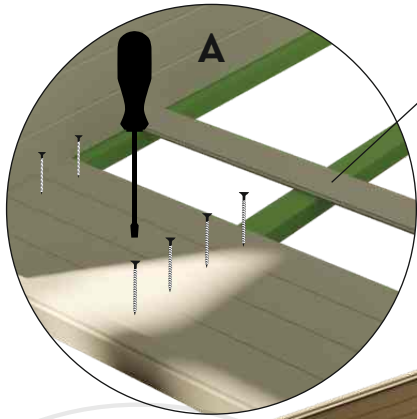

EX06 EX07 EX08



Ø 3 mm



4x50 mm



A05

B03

106

105

B

A

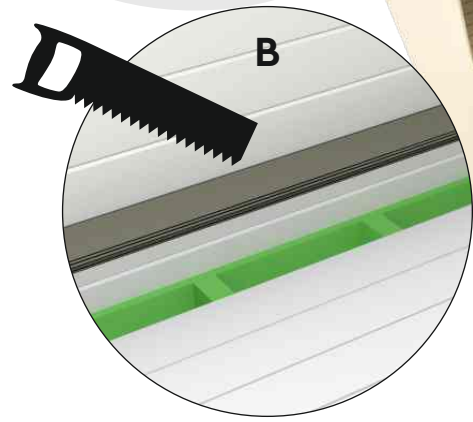

304

# PERTTI 70

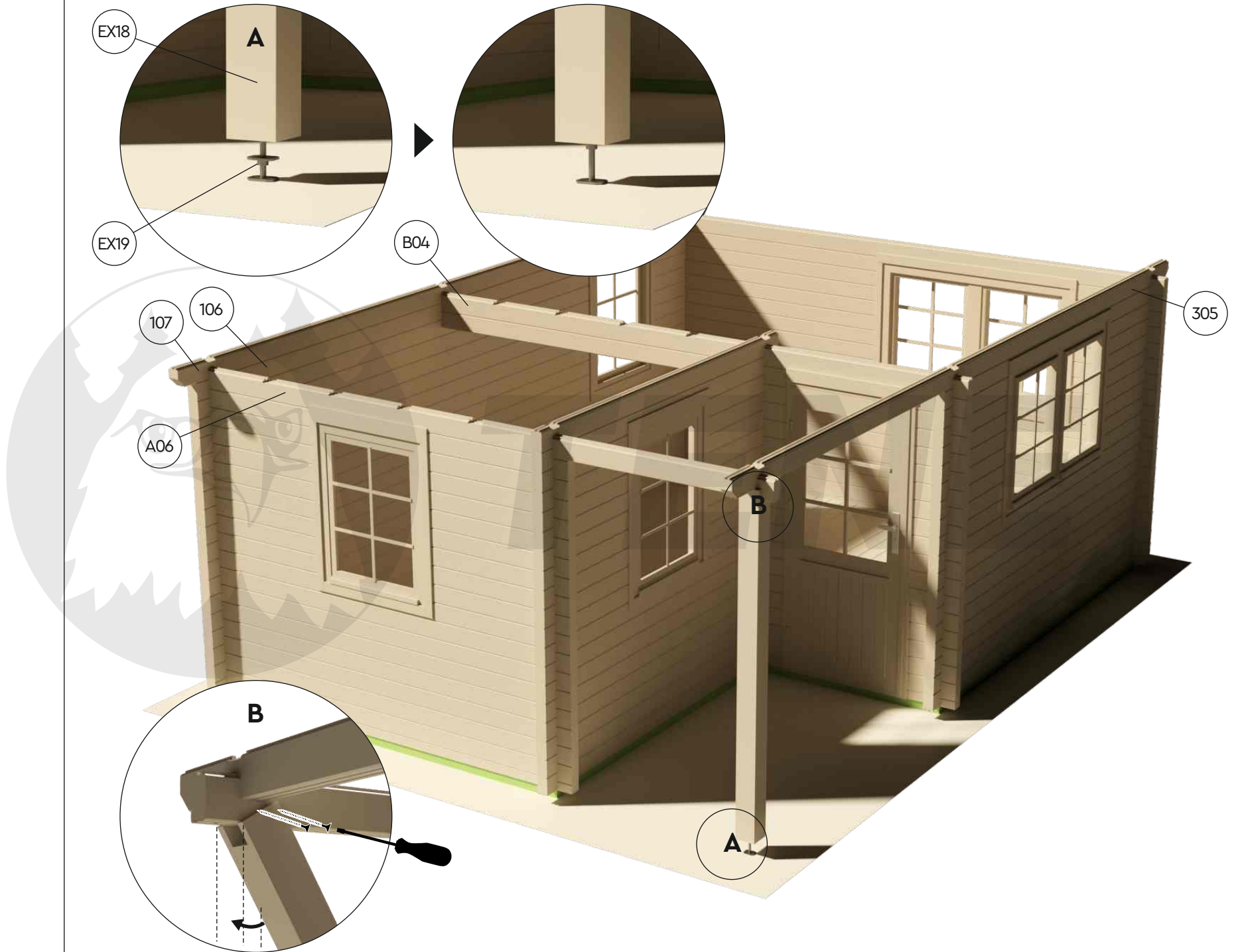

# PERTTI 70

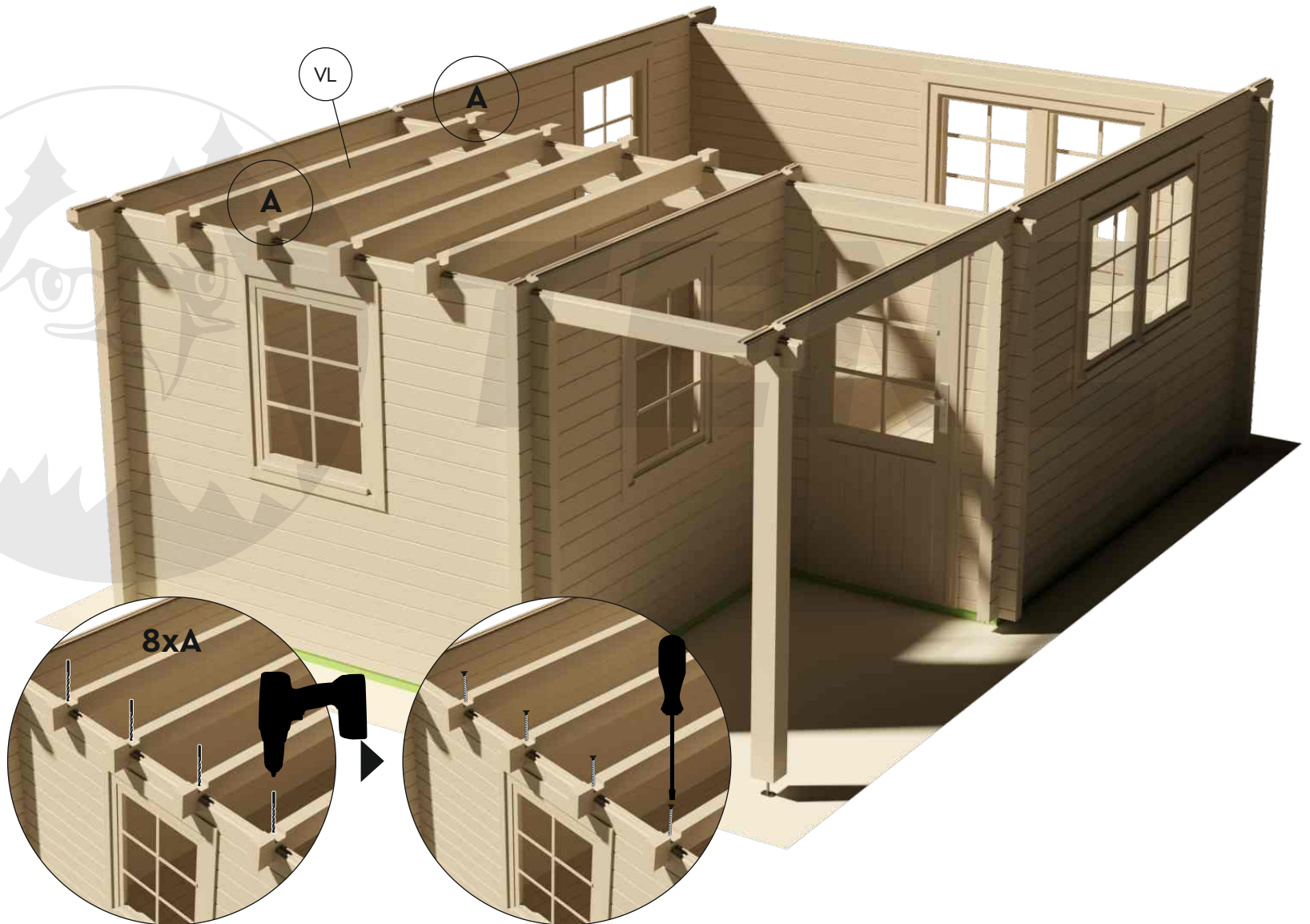
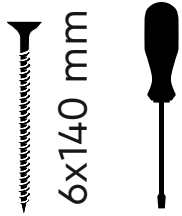

# PERTTI 70

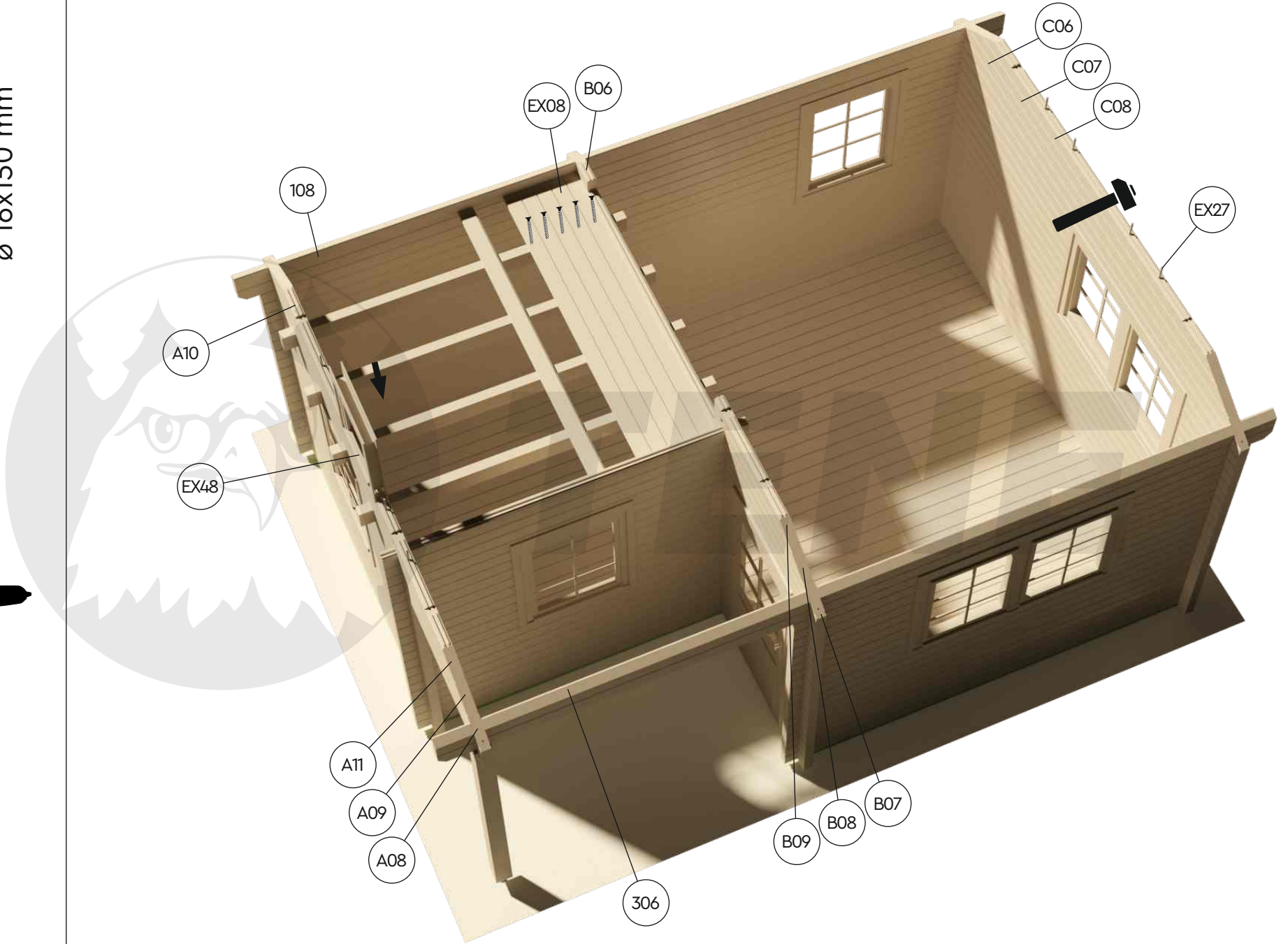
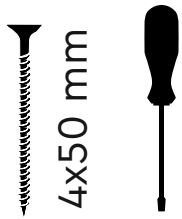

# PERTTI 70

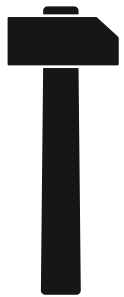
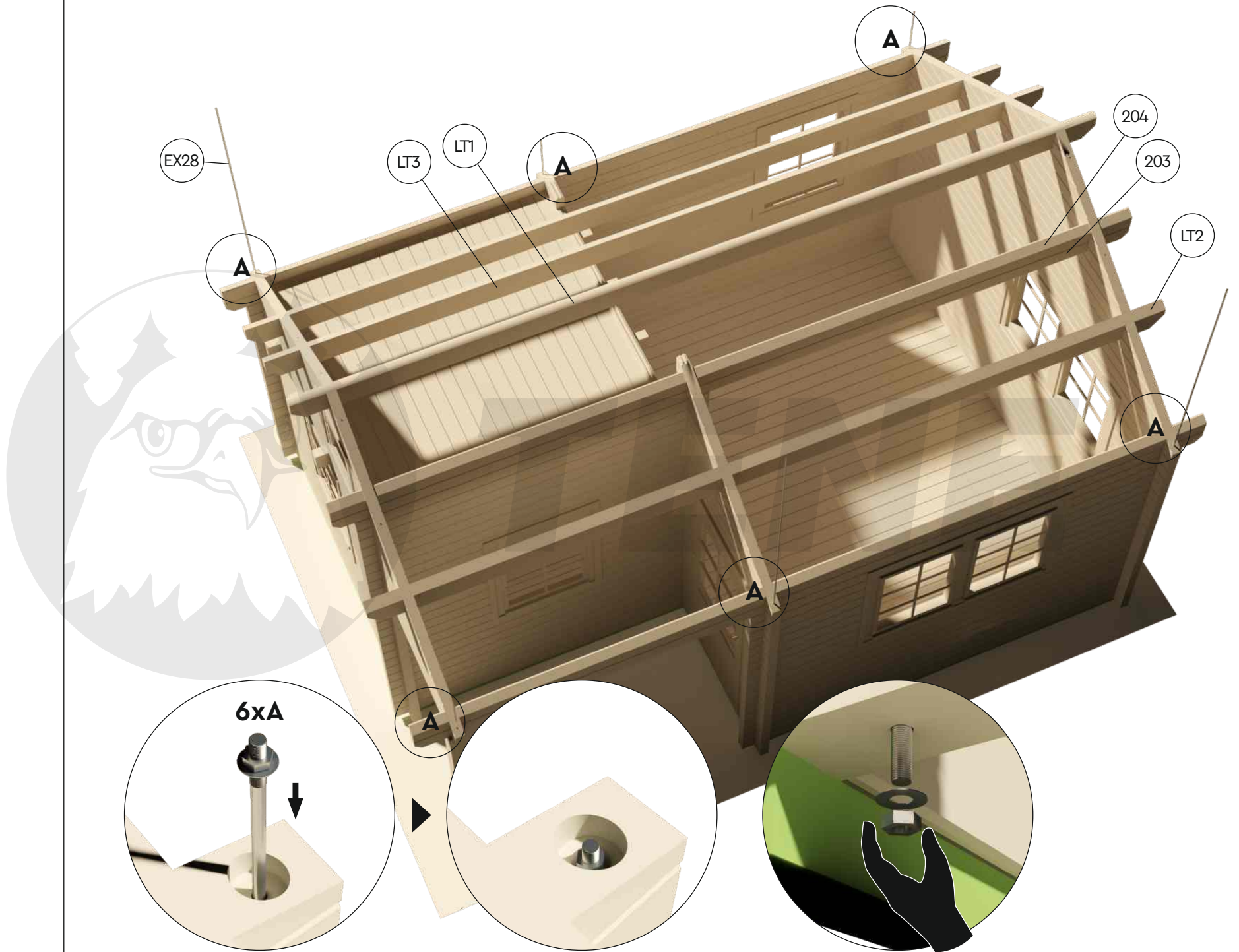

# PERTTI 70



Ø 4 mm



Ø 3 mm



5x70 mm



4x40 mm

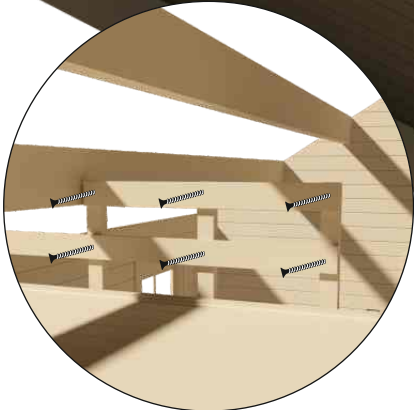
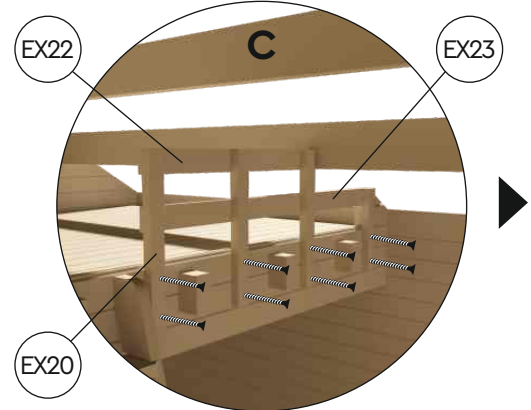
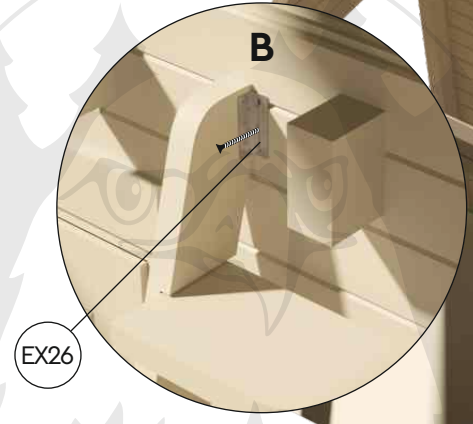
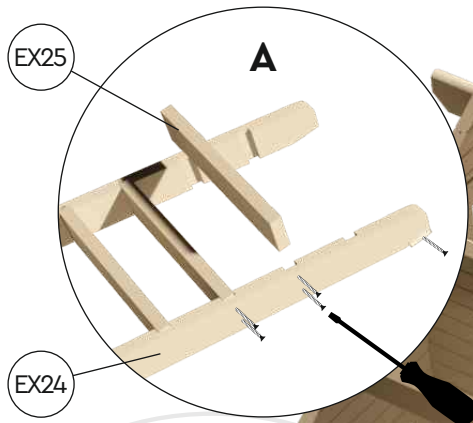
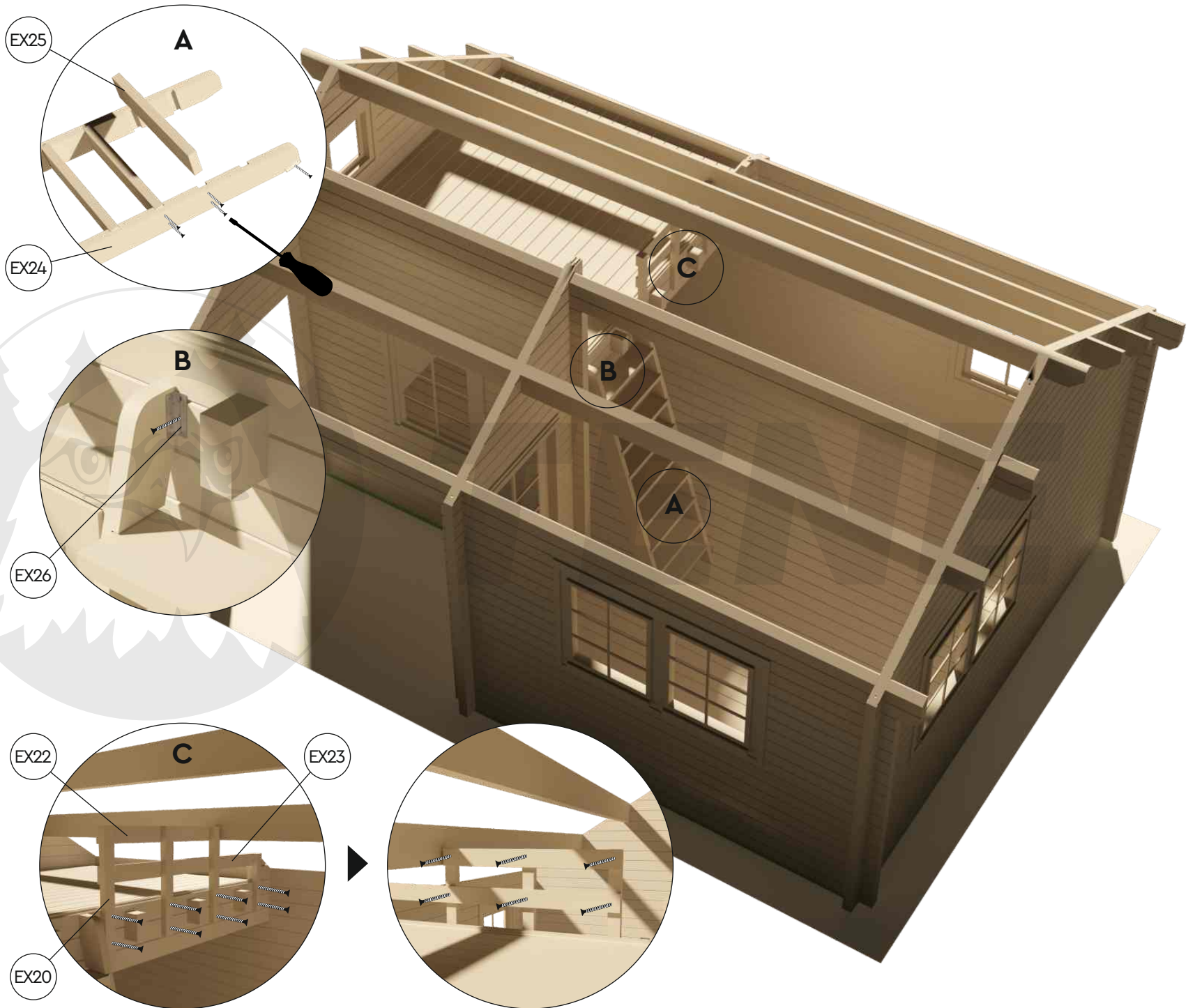

# PERTTI 70

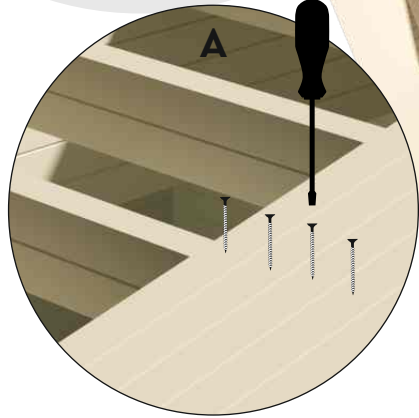
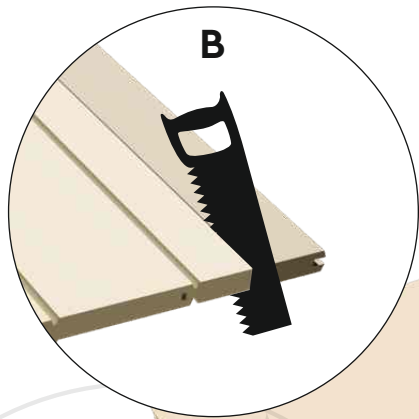

B

EX09

A

B

A

# PERTTI 70

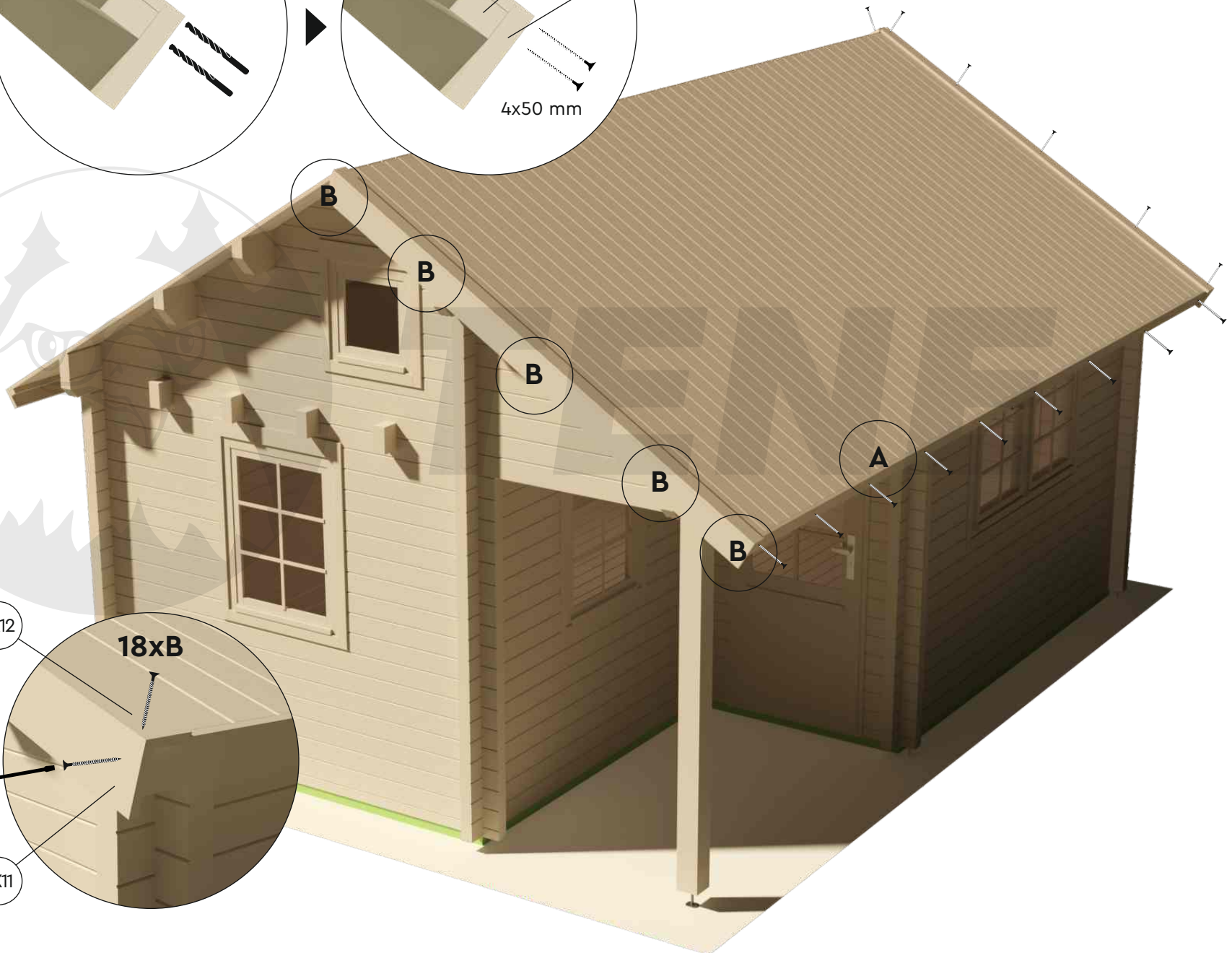
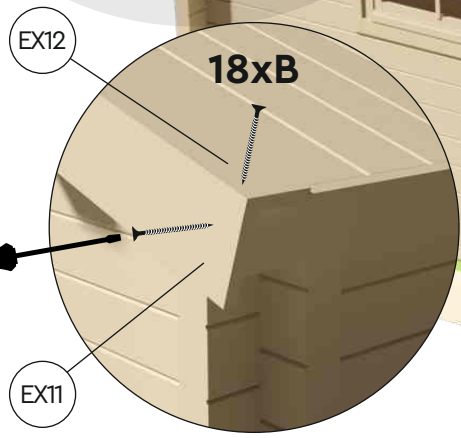
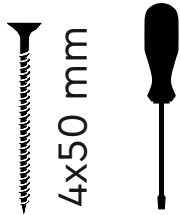
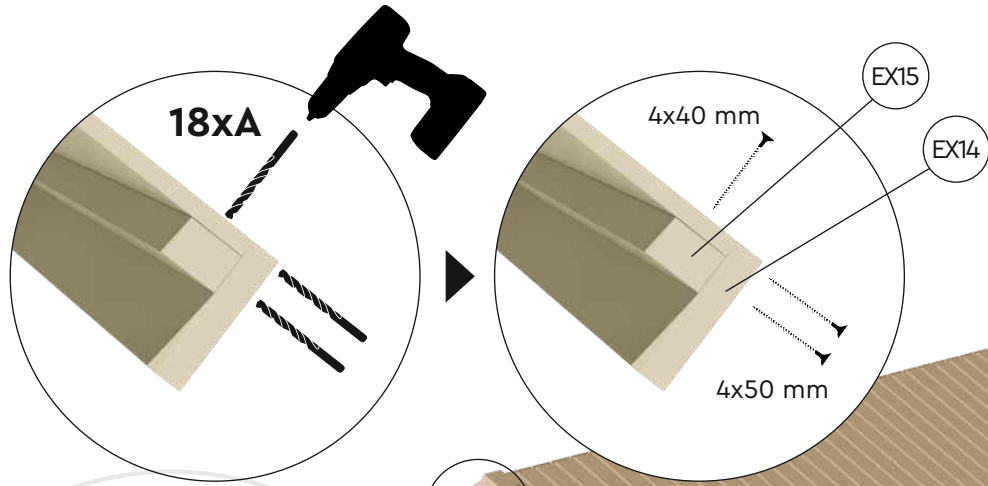

# PERTTI 70

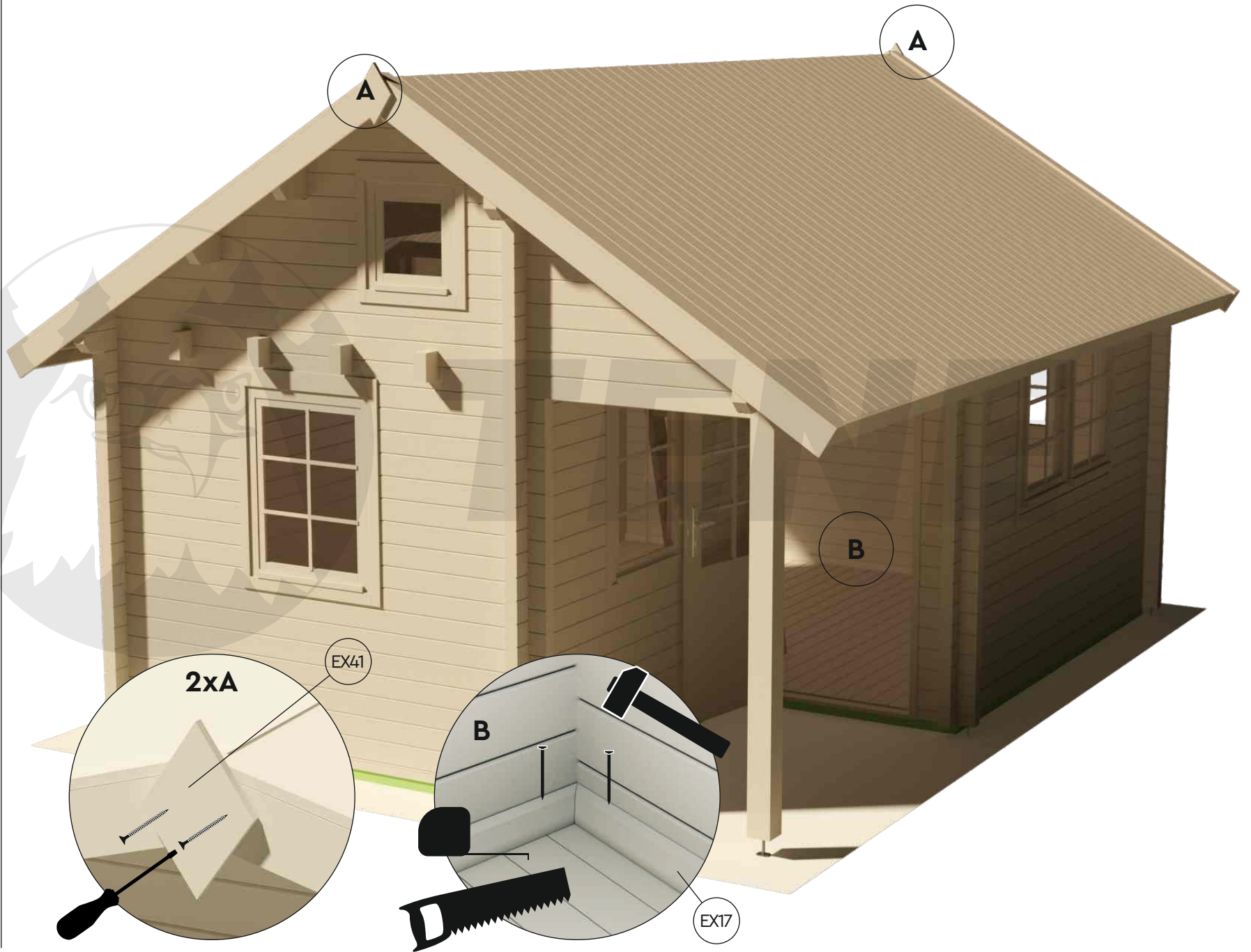
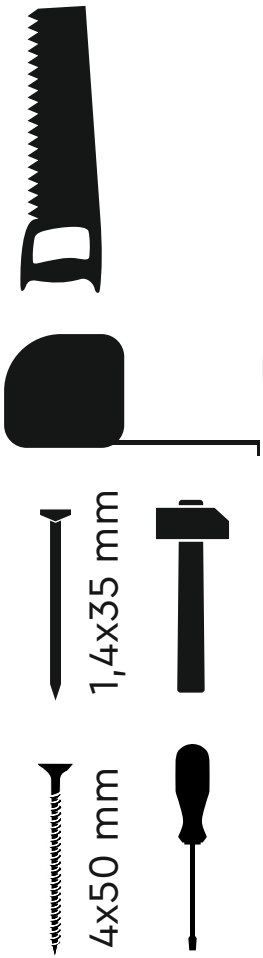

**PERTTI 70**

