

RAKENTEET

YP.
 HUOPAKATE / PELTIKATE
 BITUMIALUSKATE
 RAAKAPONTTILAUDOITUS 23 mm
 NR-KEHÄRISTIKKO

US. SIVUSEINÄ
 PYSTYPANELOINTI 20 mm
 VAAKAKOOLAUS 32x100 k600
 NR-KEHÄRISTIKON PYSTYPUU 42x148 k600

US. PÄÄTYSEINÄ
 PYSTYPANELOINTI 20 mm
 VAAKAKOOLAUS 32x100 k600
 RUNKOTOLPPA 42x98 k600

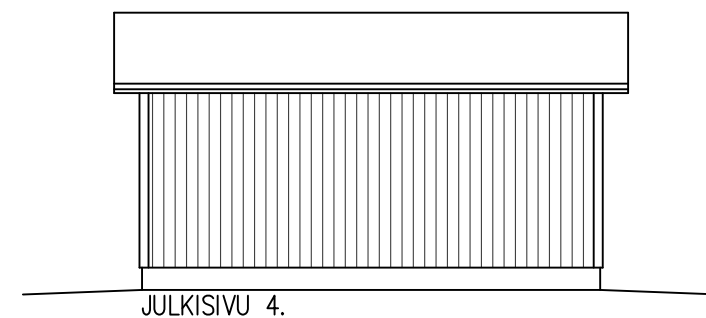
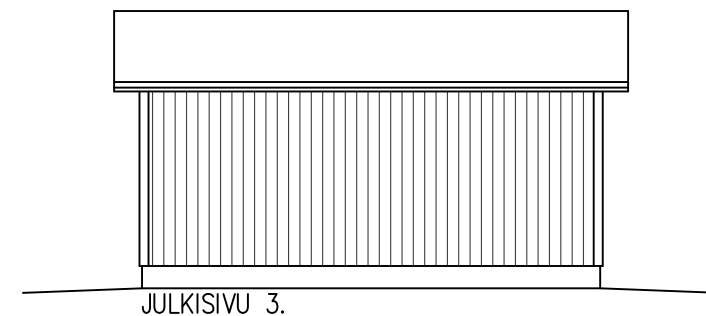
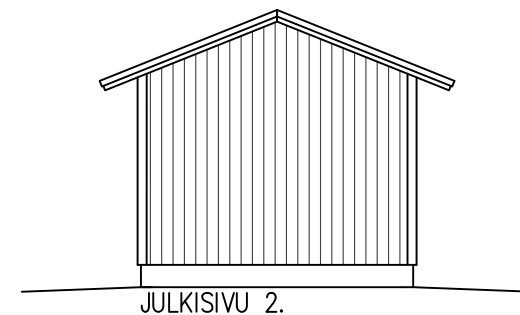
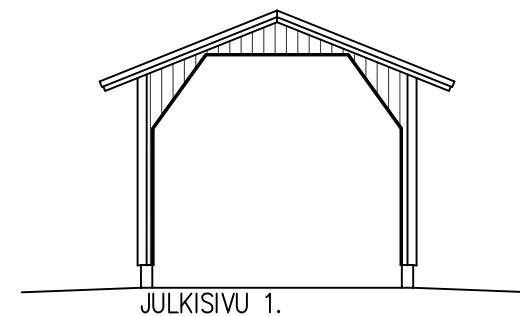
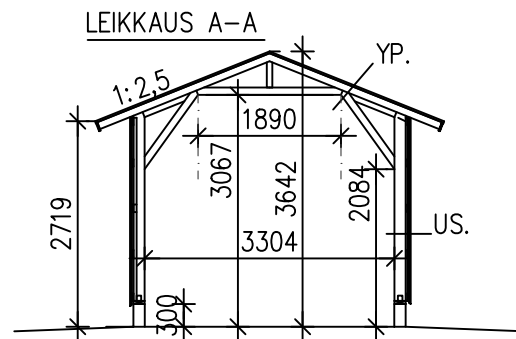

KERROSALA 23,0 m²
 TILAVUUS 75 m³

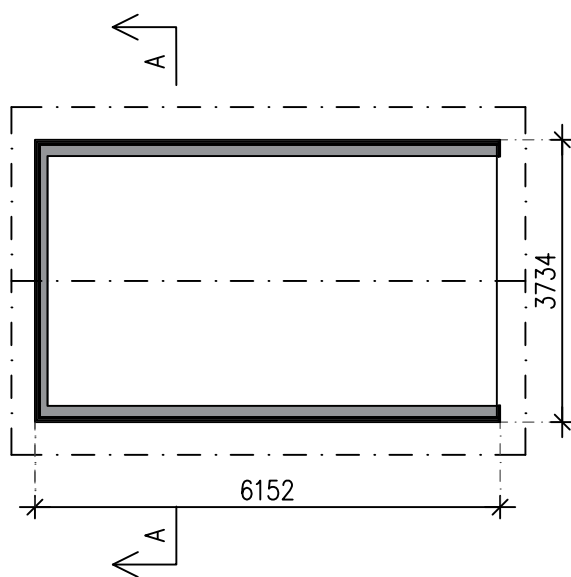

RAKENTEET

YP.
 HUOPAKATE / PELTIKATE
 BITUMIALUSKATE
 RAAKAPONTTILAUDOITUS 23 mm
 NR-KEHÄRISTIKKO

US. SIVUSEINÄ
 PYSTYPANELOINTI 20 mm
 VAAKAKOOLAUS 32x100 k600
 NR-KEHÄRISTIKON PYSTYPUU 42x148 k600

US. PÄÄTYSEINÄ
 PYSTYPANELOINTI 20 mm
 VAAKAKOOLAUS 32x100 k600
 RUNKOTOLPPA 42x98 k600

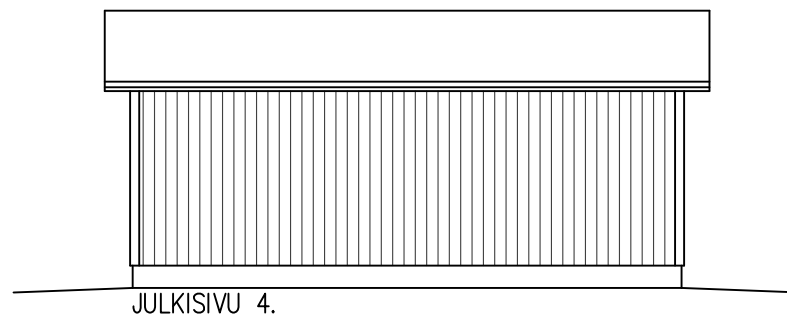
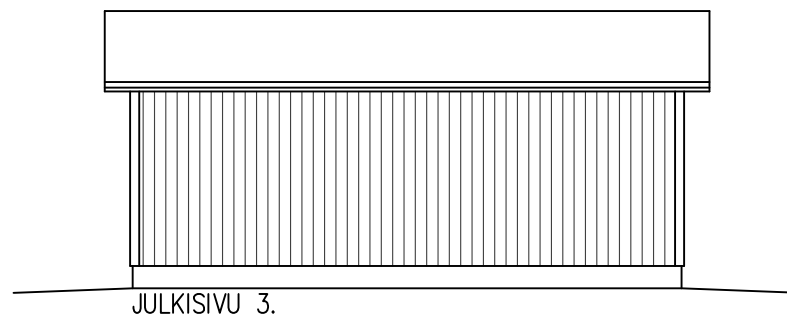
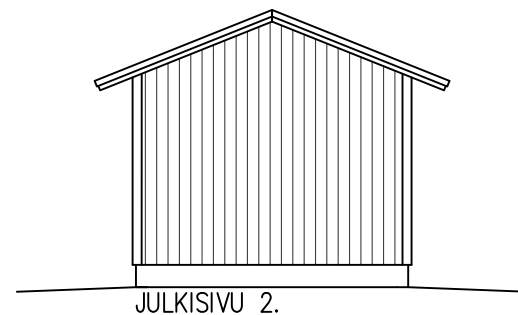
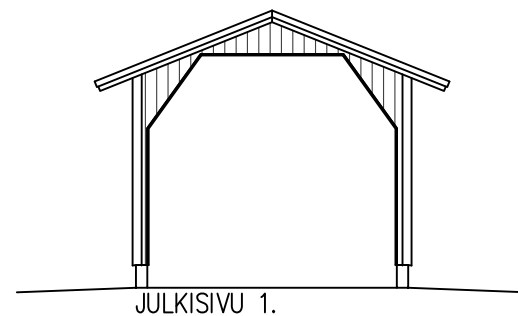
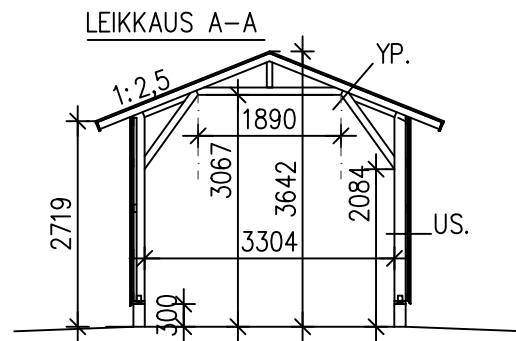

KERROSALA 27,6 m²
 TILAVUUS 90 m³

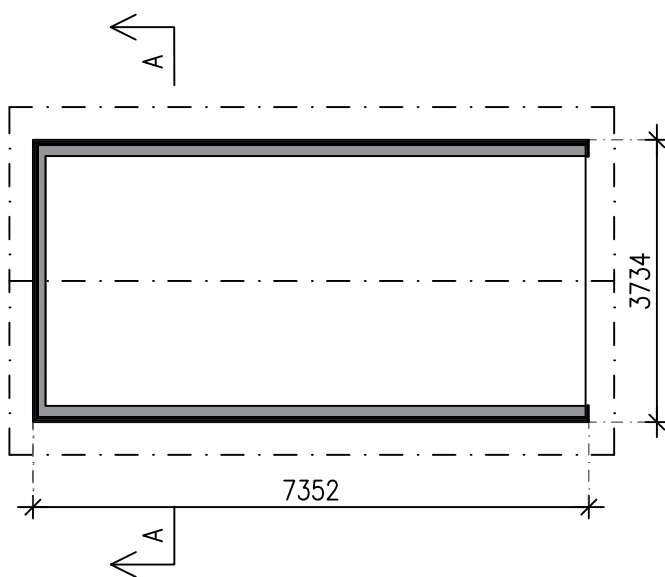

RAKENTEET

YP.
 HUOPAKATE / PELTIKATE
 BITUMIALUSKATE
 RAAKAPONTTILAUDOITUS 23 mm
 NR-KEHÄRISTIKKO

US. SIVUSEINÄ
 PYSTYPANELOINTI 20 mm
 VAAKAKOOLAUS 32x100 k600
 NR-KEHÄRISTIKON PYSTYPUU 42x148 k600

US. PÄÄTYSEINÄ
 PYSTYPANELOINTI 20 mm
 VAAKAKOOLAUS 32x100 k600
 RUNKOTOLPPA 42x98 k600

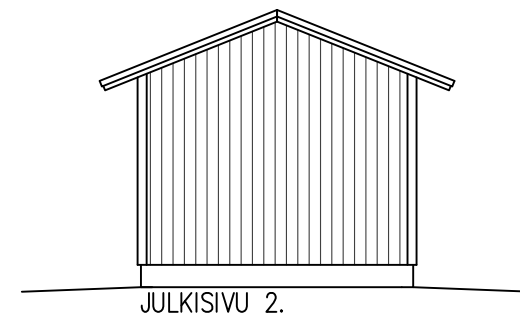
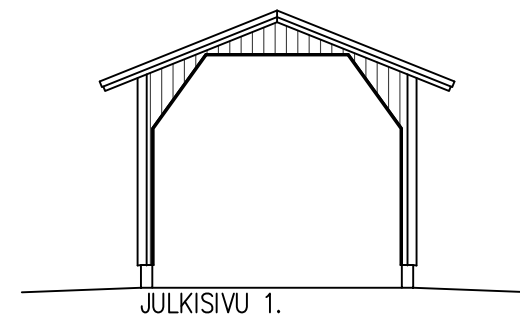
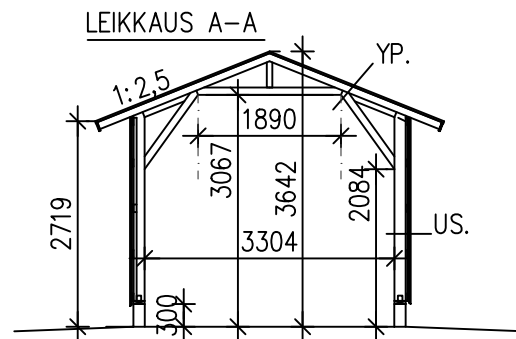

KERROSALA 29,7 m²
 TILAVUUS 97 m³

